



**CRT® FP 00**

**HANDHELD TRANSCEIVER**

**DUAL BAND VHF-UHF**

# **USER MANUAL**

**VHF 144–146 MHz(TX–RX)**

**UHF 430–440 MHz(TX–RX)**

**FM 76–108 MHz(RX)**



**CRT®** and **SUPERSTAR®** are registered and protected brands.



## SYMBOLS DESCRIPTION

Please carefully read the instructions



Information on recycling, not throwing your material in the trash at the end of life,  
Bring it to special aera to be recycling



DC using



Keep dry



Shield symbol



CE conformity symbol



Warning



## STORAGE , TRANSPORT, USING

*Storage : Classe 1 -30/85% (° Humidity)*

*Transport :- 30/85% (° Humidity )*

*operating temperature -30 à + 50°*

*Using cycle TX 10%/RX 90%*

The CRT FP00 HAM was approved in the followed countries  
that implement the CEPT regulation TR 61/01

AT,BE,BG,CH,CY,CZ,DE,DK,EE,ES,FI,FR,GR,HR,HU,IE,IS,IT,LI,LT,LU,LV,MT,NL,NO,  
PL,PT,RO,SE,SI,SK,UK.



## CRT® FP 00

Thank you for purchasing this Radio.  
We believe this easy-to-use radio will provide reliable and dependable communication.  
CRT Radio incorporates the latest advanced technology.  
As a result, we know that you will be pleased with the quality and features of this product.



### PRECAUTIONS BEFORE USING

---

Please read the User's Manual before using. It gives you important information about how to operate the portable radio.

---

Please put the radio and accessories where the children can not touch.

---

Maintenance can only be performed by professional technicians.

---

Please use the standard battery pack and charger in order not to destroy the radio.

---

Please use the standard antenna, in order not to shorten the distance.

---

Do not expose the radio to sunlight for a long period of time, nor put it near the heat, nor use it in a high temperature environment.

---

Do not put it in extreme dust nor wet or on unsteady surfaces.

---

Keep it dry. (Rain or moisture will erode the electronic board).

---

Do not transmit when the antenna is not installed.

---

If you find bad smell or smog, please turn off the radio immediately. And take the battery off the radio, then contact with CRT agent.

---



## FEATURES

- UHF/VHF dual band receive/transmit
- Receptor 76-108 MHz
- Large LCD display
- High capacity Li-ion battery and smart charger
- PC programmable
- Fast MENU operation
- Emergency alarm function
- H/L output power selective
- Squelch level adjustable
- Multi power saving function
- Voice prompt(Chinese or English)
- Reminding switch
- Dual display of frequency and channel
- Channel name edit
- Channel storing
- Frequency/Channel mode shift
- Multi LCD backlight selective
- Time of backlight auto off selective
- VOX function
- Dual-watch operation
- Receive/Transmit code setting separately
- Cable clone
- CTCSS/DCS code search automatically
- Frequency deviation and offset direction setting
- Multi step frequency
- Busy channel lock
- Time-out-timer(TOT)
- Multi display mode: channel/channel-frequency/channel name
- Multi scan function selective
- Channel scan additive
- Wide/Narrow bandwidth selective
- Main/Sub channel shift
- 1750Hz call tone
- Reminding of repeater transfer
- Auto-keylock
- 128 channels
- Channel delete function
- Reset
- DTMF function
- PTT-ID
- CTCSS/DCS
- Reverse function
- Stun/Kill/Revive
- Single call/Group call/Troop call



## CONTENTS

<b>SUPPLIED ACCESSORIES</b> .....	01
<b>READY TO WORK</b> .....	02
CHARGING NOTES (1) .....	02
CHARGING NOTES (2) .....	03
INSTALLING ANTENNA .....	04
INSTALLING BELT CLIP .....	04
INSTALLING EXTERNAL SPEAKER/MICROPHONE .....	05
ATTACHING THE BATTERY PACK .....	06-07
<b>DIAGRAM</b> .....	08
<b>BASIC OPERATION</b> .....	09
LCD DISPLAY .....	09
LCD ICON EXPLANATION .....	09
SHORTCUT KEYS .....	10-12
<b>MENU FUNCTIONS</b> .....	13
<b>FAST MENU OPERATION FLOW</b> .....	14-22
<b>FUNCTION OPERATION AND DESCRIPTION</b> .....	23
SQUELCH LEVEL (SQL) .....	23



## CONTENTS

STEP FREQUENCY(STEP) .....	23
OUTPUT POWER (TXP) .....	24
BATTERY SAVING (SAVE) .....	24
VOX FUNCTION (VOX) .....	25
WIDE/NARROW BANDWIDTH (W/N) .....	25
AUTO BACKLIGHT (ABR) .....	26
DUAL-WATCH OPERATION (TDR) .....	26
KEYPAD SOUND REMINGDING (BEEP) .....	27
TIME-OUT-TIMER (TOT) .....	27
RECEIVING DCS (R-DCS) .....	28
RECEIVING CTCSS (R-CTCS) .....	28
TRANSMITTING DCS (T-DCS) .....	29
TRANSMITTING CTCSS (T-CTCS) .....	29
VOICE REMINDING (VOICE) .....	30
ANI-ID (ANI-ID) .....	30
DTMFST(DTMFST) .....	31
SIGNAL CODE (S-CODE) .....	31



## CONTENTS

SCAN RESUMED MODE .....	32
PTT ID (PTT-ID) .....	32
PTT ID PROLONG TIME (PTT-LT) .....	33
A CHANNEL DISPLAY MODE (MDF-A) .....	33
B CHANNEL DISPLAY MODE (MDF-B) .....	34
BUSY CHANNEL LOCK (BCL) .....	34
AUTO KEYPAD LOCK (AUTOLK) .....	35
FREQUENCY OFFSET DIRECTION SETTING (SFT-D) .....	35
FREQUENCY DEVIATION (OFFSET) .....	36
CHANNEL STORE (MEM-CH) .....	36-37
CHANNEL DELETE (DEL-CH) .....	38
STANDBY BACKLIGHT (WT-LED) .....	38
RX BACKLIGHT (RX-LED) .....	39
TX BACKLIGHT (TX-LED) .....	39
ALARM MODE (AL-MOD) .....	40
OPTIONAL SIGNAL (OPTSIG) .....	40
MUTE MODE SELECTION (SPMUTE) .....	41



CONTENTS

TAIL TONE ELIMINATION (STE) .....	41
TAIL TONE ELIMINATION WHEN THROUGH REPEATER (RP-SET) .....	42
DELAY TIME OF TAIL TONE ELIMINATION WHEN THROUGH REPEATER (RPT-RL) .....	42
DISPLAYS WHEN POWER ON (PONMSG) .....	43
CALL END WARNING TONE (ROGER) .....	43
DUAL-WATCH OPERATION (TDR-AB) .....	44
RESET (RESET) .....	44
VFO-MENU INITIALIZATION .....	45
ALL-MENU AND CHANNEL INITIALIZATION .....	45
MANUALLY LOCK THE KEYPADS .....	45
RECEPTOR .....	46
RAPID ALERT (ALARM) .....	46
JACKLIGHT .....	47
MONITOR (MON) .....	47
CABLE CLONE (COPING) .....	47
CHANNEL/FREQUENCY MODE CONVERSION (VFO/MR) .....	47
TX 1750Hz CALL TONE .....	47



CONTENTS

REVERSE FUNCTION ( R ) .....	48
FREQUENCY SCANNING .....	48
CHANNEL SCANNING .....	49
AUTOMATIC SEARCH FM RADIO (FM) .....	49
SEARCH CTCSS/DCS CODE .....	50
CURSOR “▲” CONVERSION (A/B) .....	50
HIGH/LOW POWER FAST CONVERSION .....	50
STUN/KILL/REVIVE .....	51-52
SINGLE CALII/GROUP CALL/TROOP CALL .....	52-56
<b>CTCSS TABLE LIST .....</b>	<b>57</b>
<b>DCS TABLE LIST .....</b>	<b>58-59</b>
<b>SPECIFICATONS .....</b>	<b>60</b>



## SUPPLIED ACCESSORIES

Carefully unpack the portable radio. We suggest that you check the following items before you throw away the packing materials.

### STANDARD SUPPLIED ACCESSORIES

ITEM	QTY
Portable radio	1
Antenna	1
Li-ion battery (7.2V)	1
Belt clip	1
charger	1
Adapter	1
User's manual	1
Dragonnes	2

### STANDARD SUPPLIED ACCESSORIES

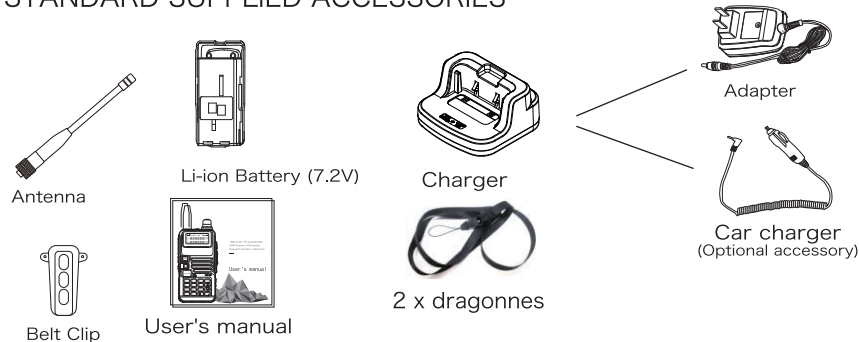

## CHARGING NOTES (1)

- ▶ Battery packs are not charged when they are shipped, charge them before use.
- ▶ Initially charging the battery pack after purchase or extended storage (longer than 2 months) will not bring the battery pack to its greatest capacity or its normal capacity, which can be done only after repeatedly charging and discharging for two or three times.

### ⚠ [ CAUTIONS ]

- After the battery is charged to its highest capacity, don't charge anymore, and remove it from the charger. Otherwise it will affect the life of the battery.
- Do not short-circuit the battery terminals or throw the battery into fire.
- Never attempt to remove the casing from the battery pack.

- ▶ Please turn the power off before charging. It will affect the battery life when charging the power-on radio.
- ▶ If the radio still shows low power after the normal charge, please change a new battery.
- ▶ The average usage time of battery pack is 13 hours. Average usage time is 5% for transmitting, 5% for receiving and 90% for standby.



## CHARGING NOTES (2)

- ▶ Plug the AC adapter into the back of the charger. Then plug the power cable of the adapter into city electric power.

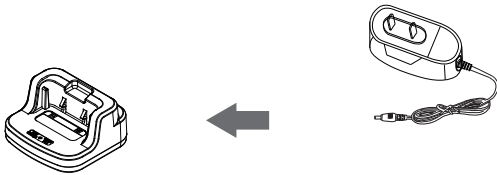

- ▶ Slide the Li-ion battery pack or radio with a Li-ion battery pack into the charger.

- Make sure the battery pack is in connected with the charging terminals.
- When charging begins, the RED LED light displays.
- When the battery pack is charged to its greatest capacity, the GREEN LED light displays. And pls remove the battery or radio from charger.

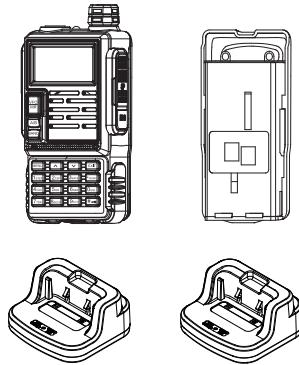

READY TO WORK

03

## INSTALLING ANTENNA

- ▶ Attach the antenna to the radio as illustrated on the right.

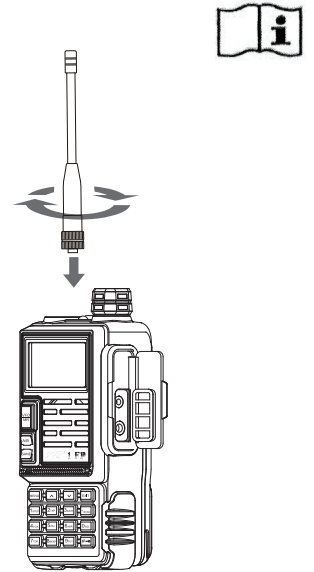

## INSTALLING BELT CLIP

- ▶ Attach the belt clip with the supplied screws by a phillips screw driver.

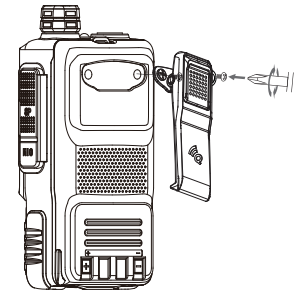

04

READY TO WORK





## INSTALLING EXTERNAL SPEAKER/MICROPHONE

- ▶ Insert the speaker/microphone plugs into the speaker/microphone jacks.

○ The radio is not fully rain resistant while using the external speaker/microphone.

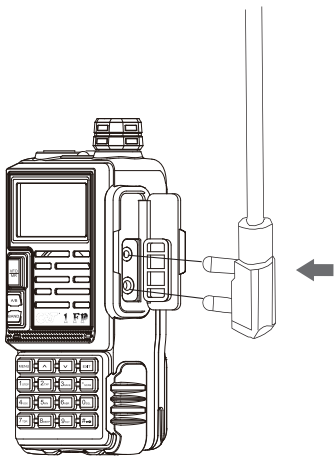

## ATTACHING THE BATTERY PACK

- ▶ Slide the battery pack into the back of the radio in the direction of the arrow(①), then lock it with the battery release button. Slide the battery pack until the battery release button makes a "clicking" sound.

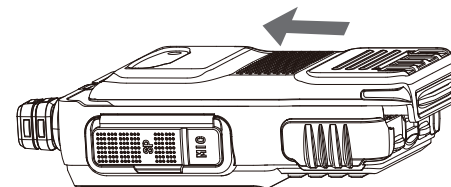



## RELEASING THE BATTERY PACK

- Turn off the radio before releasing the battery pack.
- Push the battery release button in the direction of the arrow(①)as shown below.
- At the same time push the battery back.
- The battery pack is then released.

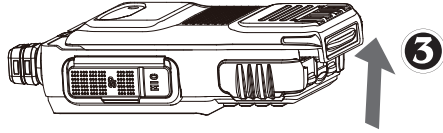
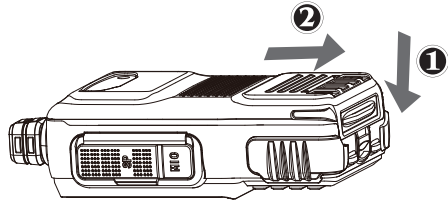

## DIAGRAM

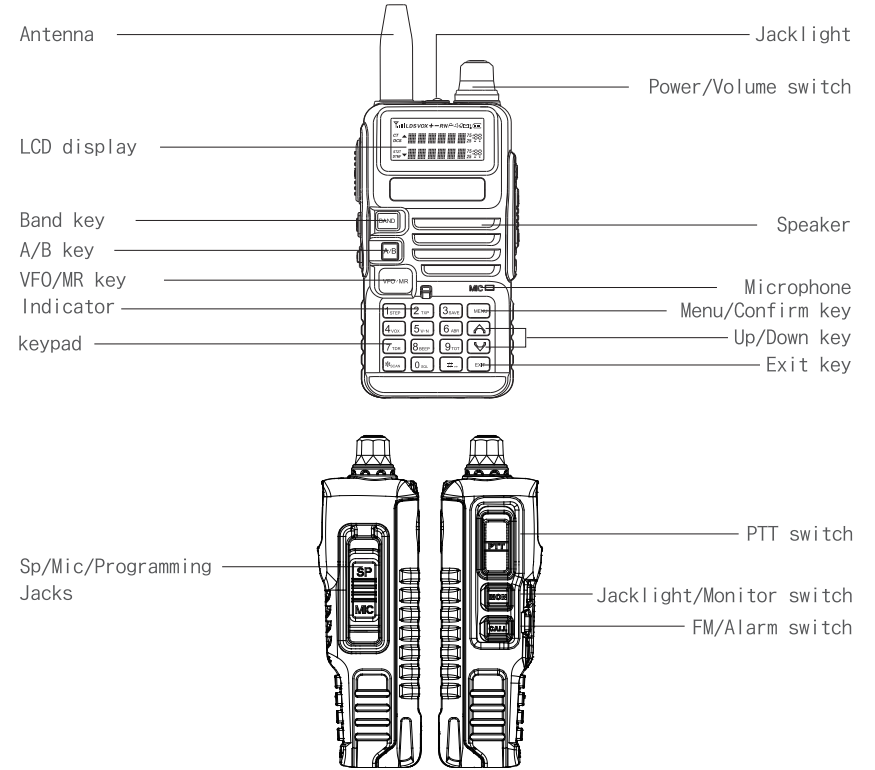



## LCD DISPLAY

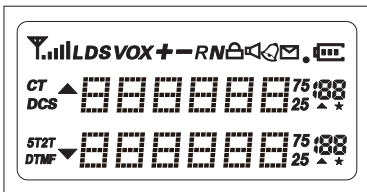

## LCD ICON EXPLANATION

<b>CT</b>	This symbol will appear when transmitting, it means transmitting CTCSS code.
<b>DCS</b>	This symbol will appear when transmitting, it means transmitting DCS code.
<b>+</b>	In frequency mode, this symbol will appear, it means transmitting frequency equals receiving frequency plus the offset frequency. It can set different frequencies.
<b>-</b>	In frequency mode, it will appear this symbol, it means transmitting frequency equals receiving frequency minus the offset frequency. It can set different frequencies.
<b>+/-</b>	It means the transmitting and receiving frequencies are different at current channel.
<b>S</b>	It means it already set dual watch operation function.
<b>VOX</b>	VOX function
<b>R</b>	Reverse function
<b>N</b>	Narrow bandwidth
	It represents the remaining battery. when the battery is almost used up, the frame starts to flicker and it forbids to transmit.
	It means the keypad is locked, pressing key #/Lock can unlock the keypad.
<b>L</b> ▲▼	Low output power. Current frequency and current menu setting.
	Signal strength.
<b>88</b>	Channel number display
<b>75</b> <b>25</b>	Frequency ending display



## BASIC OPERATION

### ▶ PTT Key

- Transmitting/Receiving switch key: Press "PTT" to transmit and speak to microphone.
- Release "PTT" to receive.

### ▶ CALL Key (FM/Alarm)

- Press it for a short time to turn on FM radio function. Operate it again to turn it off.
- Press it for a long time to turn on Alarm function. Operate it again to turn it off.

### ▶ MON Key (Jacklight/Monitor)

- Press it for a short time to turn on Jacklight. Operate it again to turn it off.
- Press it for a long time to turn on Monitor function.
- Press Jacklight/Monitor key and turn the power on, to enter channel clone condition, it can copy one radio's channel parameters to another one. Cloning cable must be used to connect these two radios.

### ▶ LCD Display

- Display all the working condition.

### ▶ Band Key

- UHF/VHF frequency band shift;
- RECEPTOR 76-108MHz shift;
- In transmitting mode, press Band key to send 1750Hz call tone.



## BASIC OPERATION

### ▶ Function Keypads

- Menu/Confirm key: It' s used for activating the menu, choose each menu item and confirm the parameter.
- Up key (Press more than 2s, the channel and frequency will move upward rapidly; In scannig, press Up key to upward scanning.):
- Down key (Press more than 2s, the channel and frequency will move downward rapidly; In scannig, press Up key to downward scanning):
- Press key Exit to exit and clear:

### ▶ Number Keypads

- Input the information to the radio.
- Input the non-standard CTCSS code in non-standard mode.
- In transmitting mode, press number keys to send corresponding DTMF code.



## BASIC OPERATION

### ▶ \*SCAN Key

- Press Scan key for a short time to activate RX/TX reverse function.
- Press Scan key for more than 2s to start frequency or channel scanning.
- In FM radio mode, press Scan key to automatically search FM stations.
- In CTCSS/DCS mode, press Scan key to start CTCSS/DCS code scanning.

### ▶ # r-o Key

- In channel mode, press # r-o for a short time to switch H/L output power.
- Press # r-o key for more than 2 seconds to lock or unlock the keypad.

### ▶ Power/Volume Switch

- Turn the Power/Volume switch clockwise to turn the power on.  
Turn the Power/Volume switch counter-clockwise to turn the power off.
- Turn the Power/Volume switch clockwise to volume up, otherwise it' s volume down.

### ▶ Indicator

- Transmitting: the red light glitter
- Receiving: the green light glitter

### ▶ Sp/Mic/Programming Jacks

- It' s used for external speaker/microphone.
- It' s used to connect cable for computer programming or application upgrade.



## FAST MENU SETTING

- 1 Press Menu key;
- 2 Press Menu key again;
- 3 Press Up/Down key to select Menu No.
- 4 press Menu to confirm or EXIT key to exit(As picture below).



### NOTE

- ① In channel mode, the setting of following features is invalid:  
CTCSS/DCS, Wide/Narrow bandwidth, PTT-ID.  
Busy channel lock, Channel scan additive, Channel name edit.
- ② High/Low power can only be changed by pressing fast key #.



## FAST MENU OPERATION FLOW

No.	Feature	Function Character	Function Set	LCD Display	Parameter	LCD Display	Selectable	Confirm key	Back Key	Page
0	Squelch Level	SQL	MENU+0	▲ SQL 0 5	Press Menu key and then press ▲ or ▼ key to choose.	▼ SQL 0 6	0-9 levels 0:Lowest 9:Highest	MENU	PTT/ EXIT	P22
1	Step Frequency	STEP	MENU+1	▲ STEP 1 20.5K	Press Menu key, and then press ▲ or ▼ key to choose.	▼ STEP 1 12.5K	2.5/5.0/6.25 /10.0/12.5/ 25.0KHZ	MENU	PTT/ EXIT	P23
2	Output Power	TXP	MENU+2	▲ TXP 2 HIGH	Press Menu key, and then press ▲ or ▼ key to choose.	▼ TXP 2 LOW	HIGH: 5W LOW: 1W	MENU	PTT/ EXIT	P24
3	Battery Saving	SAVE	MENU+3	▲ SAVE 3 1	Press Menu key, and then press ▲ or ▼ key to choose.	▼ SAVE 3 2	OFF: OFF 1: 1 2: 2 3: 3 4: 4	MENU	PTT/ EXIT	P24
4	VOX	VOX	MENU+4	▲ VOX 4 OFF	Press Menu key, and then press ▲ or ▼ key to choose.	▼ VOX 4 9	OFF: OFF 10: Lowest Sensitivity 1: Highest Sensitivity	MENU	PTT/ EXIT	P25
5	Channel Bandwidth	WN	MENU+5	▲ WN 5 WIDE	Press Menu key, and then press ▲ or ▼ key to choose.	▼ WN 5 NARR	W: 25.0K N: 12.5K	MENU	PTT/ EXIT	P25
6	Auto Backlight	ABR	MENU+6	▲ ABR 6 OFF	Press Menu key, and then press ▲ or ▼ key to choose.	▼ ABR 6 NARR	OFF: 1-5s	MENU	PTT/ EXIT	P26



## FAST MENU OPERATION FLOW

No.	Feature	Function Character	Function Set	LCD Display	Parameter	LCD Display	Selectable	Confirm key	Back Key	Page
7	Dual-watch Operation	TDR	MENU+7	TDR 7 OFF	Press Menu key, and then press ▲ or ▼ key to choose.	TDR 7 ON	ON OFF	MENU	PTT/EXIT	P26
8	Keypad Sound Reminding	BEEP	MENU+8	BEEP 8 OFF	Press Menu key, and then press ▲ or ▼ key to choose.	BEEP 8 ON	O OFF	MENU	PTT/EXIT	P27
9	Time-Out-Timer	TOT	MENU+9	TOT 9 15	Press Menu key, and then press ▲ or ▼ key to choose.	TOT 9 600	15,30..... 600s	MENU	PTT/EXIT	P27
10	Receive DCS	R-DCS	MENU+10	R-DCS 10 OFF	Press Menu key, and then press ▲ or ▼ key to choose.	R-DCS 10 D023N	OFF D023N-D754N D023H-D754I	MENU	PTT/EXIT	P28
11	Receive CTCSS	R-CTCS	MENU+11	R-CTCS 11 OFF	Press Menu key, and then press ▲ or ▼ key to choose.	R-CTCS 11 67.0HZ	OFF 67.0-254.1HZ	MENU	PTT/EXIT	P28
12	Transmit DCS	T-DCS	MENU+12	T-DCS 12 OFF	Press Menu key, and then press ▲ or ▼ key to choose.	T-DCS 12 D023N	OFF D023N-D754N D023H-D754I	MENU	PTT/EXIT	P29
13	Transmit CTCSS	T-CTCS	MENU+13	T-CTCS 13 OFF	Press Menu key, and then press ▲ or ▼ key to choose.	T-CTCS 13 67.0HZ	OFF 67.0-254.1HZ	MENU	PTT/EXIT	P29



## FAST MENU OPERATION FLOW

No.	Feature	Function Character	Function Set	LCD Display	Parameter	LCD Display	Selectable	Confirm key	Back Key	Page
14	Voice Reminding	VOICE	MENU+14	VOICE 14 OFF	Press Menu key, and then press ▲ or ▼ key to choose.	VOICE 14 ON	ON OFF	MENU	PTT/EXIT	P30
15	ANI-ID	ANI-ID	MENU+15	ANI-ID 15 *****	Press Menu key, and then press ▲ or ▼ key to choose.	ANI-ID 15 *****	1-5digit arbitrary selection(it can be programmed by software.)	MENU	PTT/EXIT	P30
16	DTMFST	DTMFST	MENU+16	DTMFST 16 OFF	Press Menu key, and then press ▲ or ▼ key to choose.	DTMFST 16 DT-ST	OFF DT-ST:Sending by keypads ANI-ST:Auto sending DT+ANI:Auto sending and sending by keypads	MENU	PTT/EXIT	P31
17	Signal Code	S-CODE	MENU+17	S-CODE 17 1	Press Menu key, and then press ▲ or ▼ key to choose.	S-CODE 17 13	1-15 group (it can be programmed by software.)	MENU	PTT/EXIT	P31
18	Scan Resumed Mode	SC-REV	MENU+18	SC-REV 18 TO	Press Menu key, and then press ▲ or ▼ key to choose.	SC-REV 18 SE	TO:Time scanning CO:Carrier wave scanning SE:Search scanning	MENU	PTT/EXIT	P32
19	PTT ID	PTT-ID	MENU+19	PTT-ID 19 OFF	Press Menu key, and then press ▲ or ▼ key to choose.	PTT-ID 19 BOT	OFF:Press PTT not to send. BOT:Press PTT to send.(PTT ID code can choose from program software. EOT:Release PTT to send. BOTH:Press or release PTT to send.	MENU	PTT/EXIT	P32
20	PTT ID Prolong Time	PTT-LT	MENU+20	PTT-LT 20 0	Press Menu key, and then press ▲ or ▼ key to choose.	PTT-LT 20 1	0,1,2..... 30ms	MENU	PTT/EXIT	P33



## FAST MENU OPERATION FLOW

No.	Feature	Function Character	Function Set	LCD Display	Parameter	LCD Display	Selectable	Confirm key	Back Key	Page
21	A Channel Display Mode	MDF-A	MENU+21	▲MDF-A 21 FREQ	Press Menu key, and then press ▲ or ▼ key to choose.	MDF-A 21 CH	FREQ:Channel+ frequency CH: Channel NAME:Channel name(It can be programmed by software.)	MENU	PTT/ EXIT	P33
22	B Channel Display Mode	MDF-B	MENU+22	▲MDF-B 22 FREQ	Press Menu key, and then press ▲ or ▼ key to choose.	MDF-B 22 CH	FREQ:Channel+ frequency CH: Channel NAME:Channel name(It can be programmed by software.)	MENU	PTT/ EXIT	P34
23	Busy Channel Lock	BCL	MENU+23	▲BCL 23 OFF	Press Menu key, and then press ▲ or ▼ key to choose.	BCL 23 ON	ON OFF	MENU	PTT/ EXIT	P34
24	Auto Keypad Lock	AUTOLK	MENU+24	▲AUTOLK 24 OFF	Press Menu key, and then press ▲ or ▼ key to choose.	AUTOLK 24 ON	ON OFF	MENU	PTT/ EXIT	P35
25	Frequency Offset Direction Setting	SFT-D	MENU+25	▲SFT-D 25 OFF	Press Menu key, and then press ▲ or ▼ key to choose.	SFT-D 25 ON	OFF +:TX frequency >RX frequency -:TX frequency <RX frequency	MENU	PTT/ EXIT	P35
26	Frequency Deviation	OFFSET	MENU+26	▲OFFSET 26 00,000	Press Menu key, and then press ▲ or ▼ key to choose.	OFFSET 26 05,000	00,000- 69,9975MHZ	MENU	PTT/ EXIT	P36
27	Channel Store	MEM-CH	MENU+27	▲MEM-CH 27 000	Press Menu key, and then press ▲ or ▼ key to choose.	MEM-CH 27 036	0-1 27 Channels	MENU	PTT/ EXIT	P36-37

FAST MENU OPERATION FLOW

17



## FAST MENU OPERATION FLOW

No.	Feature	Function Character	Function Set	LCD Display	Parameter	LCD Display	Selectable	Confirm key	Back Key	Page
28	Channel Delete	DEL-CH	MENU+28	▲DEL-CH 28 000	Press Menu key, and then press ▲ or ▼ key to choose.	DEL-CH 28 006	Any one of the stored channels.	MENU	PTT/ EXIT	P38
29	Standby Backlight	WT-LED	MENU+29	▲WT-LED 29 OFF	Press Menu key, and then press ▲ or ▼ key to choose.	WT-LED 29 SKY BLUE	OFF GREEN PURPLE SKY BLUE	MENU	PTT/ EXIT	P38
30	RX Backlight	RX-LED	MENU+30	▲RX-LED 30 OFF	Press Menu key, and then press ▲ or ▼ key to choose.	RX-LED 30 GREEN	OFF GREEN PURPLE SKY BLUE	MENU	PTT/ EXIT	P39
31	TX Backlight	TX-LED	MENU+31	▲TX-LED 31 OFF	Press Menu key, and then press ▲ or ▼ key to choose.	TX-LED 31 PURPLE	OFF GREEN PURPLE SKY BLUE	MENU	PTT/ EXIT	P39
32	Alarm Mode	AL-MOD	MENU+32	▲AL-MOD 32 OFF	Press Menu key, and then press ▲ or ▼ key to choose.	AL-MOD 32 SITE	SITE:Site alarm TONE:Send alarm tone CODE:Send alarm code	MENU	PTT/ EXIT	P40
33	Optional Signal	OPTSIG	MENU+33	▲OPTSIG 33 DTMF	Press Menu key, and then press ▲ or ▼ key to choose.	OPTSIG 33 DTMF	ON OFF	MENU	PTT/ EXIT	P40
34	Mute Mode Selection	SPMUTE	MENU+34	▲SPMUTE 34 QT	Press Menu key, and then press ▲ or ▼ key to choose.	SPMUTE 34 QT+DT	QT: CTCSS conform to receive the call, QT+DT: CTCSS and DTMF conform to receive the call, QT+DT: CTCSS or DTMF conform to receive the call.	MENU	PTT/ EXIT	P41

FAST MENU OPERATION FLOW

18



## FAST MENU OPERATION FLOW

No.	Feature	Function Character	Function Set	LCD Display	Parameter	LCD Display	Selectable	Confirm key	Back Key	Page
35	Tail Tone Elimination	STE	MENU+35	▲ STE 35 OFF	Press Menu key, and then press ▲ or ▼ key to choose.	▼ SIT CH 35	ON OFF	MENU	PTT/EXIT	P41
36	Repeater Tail Tone Elimination	RP-STE	MENU+36	▲ RP-STE 36 OFF	Press Menu key, and then press ▲ or ▼ key to choose.	▼ RP-STE 36 5	OFF 1.2...10ms	MENU	PTT/EXIT	P42
37	Time of Repeater Tail Tone Elimination	RPT-RL	MENU+37	▲ RPT-RL 37 OFF	Press Menu key, and then press ▲ or ▼ key to choose.	▼ RPT-RL 37 5	OFF 1.2...10ms	MENU	PTT/EXIT	P42
38	Displays When Power On	PONMSG	MENU+38	▲ PONMSG 38 OFF	Press Menu key, and then press ▲ or ▼ key to choose.	▼ PONMSG 38 MSG	FULL: Full frequency character MSG: Display of NUT logo	MENU	PTT/EXIT	P43
39	Reminding of End Talk	ROGER	MENU+39	▲ ROGER 39 FULL	Press Menu key, and then press ▲ or ▼ key to choose.	▼ ROGER 39 ON	ON OFF	MENU	PTT/EXIT	P43
40	Dual-watch Operation (Cross Band TX/RX)	TDR-AB	MENU+40	▲ TDR-AB 40 OFF	Press Menu key, and then press ▲ or ▼ key to choose.	▼ TDR-AB 40 A	OFF A band transmit (Upper row frequency). A band transmit (Bottom row frequency)	MENU	PTT/EXIT	P44
41	Reset	RESET	MENU+41	▲ RESET 41 ALL	Press Menu key, and then press ▲ or ▼ key to choose.	▼ RESET 41 VFO	VFO: Menu initialization ALL: Menu and channel initialization	MENU	PTT/EXIT	P44



## FAST MENU OPERATION FLOW

No.	Feature	Function Character	Function Set	LCD Display	Parameter	LCD Display	Selectable	Confirm key	Back Key	Page
	Manually Lock the Keypads		Press key '#' for more than 2s.	▲ 400.875 136.225		▲ 400.875 136.225	Repeatedly press key '#' for more than 2s to lock or unlock.	Auto	Auto	P45
	FM Radio	FM	Slightly press Call key	▲ FM 100.700	Press BAND key, and then press ▲ or ▼ key to choose, or it can input numbers directly.	MR/VFO 76-108MHZ		Auto	PTT/CALL	P46
	Rapid Alert	ALARM	Press CALL key for more than 2s.	▲ ALARM 138.625				Auto	PTT	P46
	Jacklight		Tap MON key				Repeatedly tap MON key to turn Jacklight/Warning light off.	Auto	Auto	P47
	Monitor	MON	Press key MON for more than 2s.				Press key MON for more than 2s to turn it on. Release key MON to turn it off.	Auto	Auto	P47
	Cable Clone	COPING	Press key MON for more than 2s.	COPING				Auto	Auto	P47
	Channel / Frequency Mode Conversion	VFO/MR	Press the VFO/MR key.	▲ 400.875 136.225	Press Menu key, and then press ▲ or ▼ key to choose.	▲ 400.875 3 136.225 4	Display channel mode according to menu21 and 22.	Auto	Auto	P47



## FAST MENU OPERATION FLOW

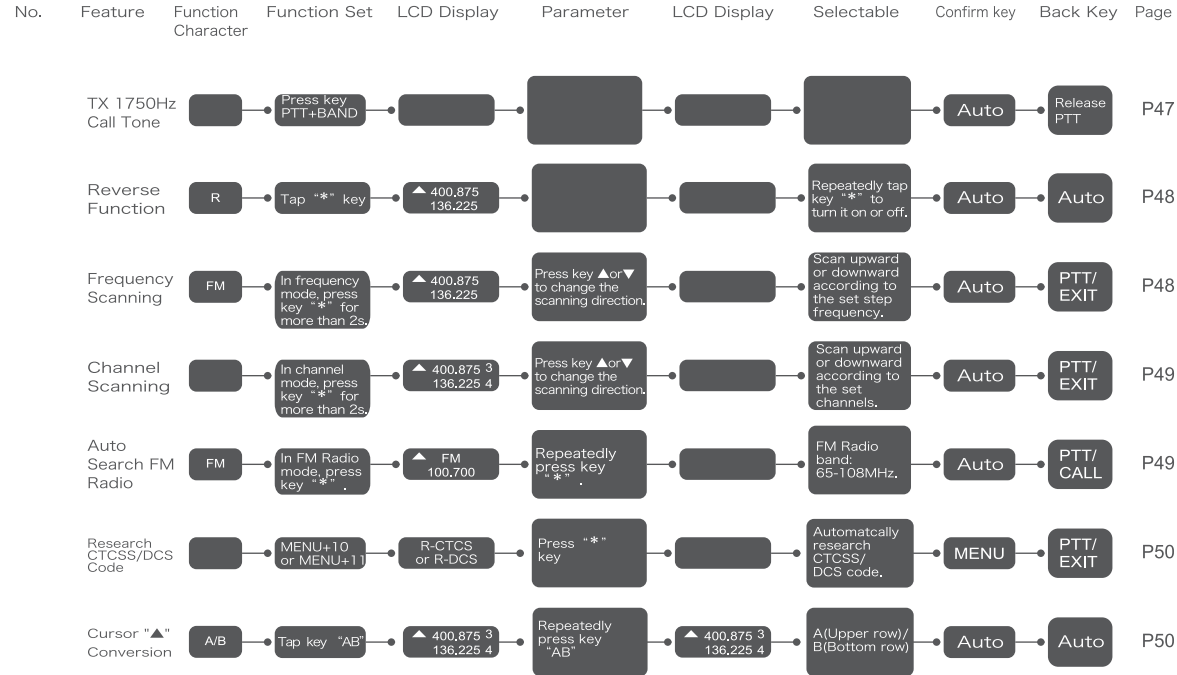

## FAST MENU OPERATION FLOW

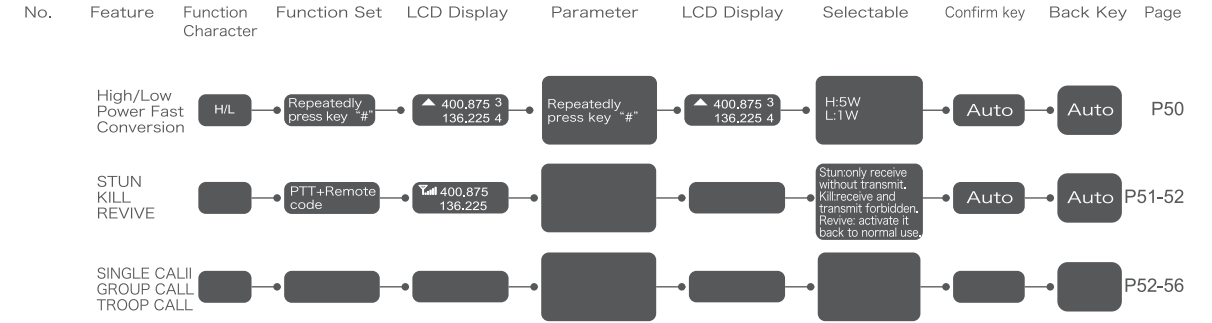



## FUNCTION OPERATION AND DESCRIPTION (The following description is without voice prompt.)

### ▶ Squelch Level (SQL) —Menu No.0

- This function can turn on or off the monitor according to signal strength.

#### The operation steps are as follows:

- In frequency or channel mode, press Menu+0, the LCD displays:
- Press key Menu, the LCD displays:
- Press key ▲ or ▼ to choose squelch level. There are 0-9 levels. 0: Lowest 9: Highest
- After setting, press key Menu to confirm, and then press key PTT or Exit to standby.

#### ▲ NOTE

- Too high squelch level may result in failing to receive in weak signals, Too low squelch level will make it be disturbed by other signals.

### ▶ Step Frequency (STEP) —Menu No.1

- This function can choose the step frequency you want to set.

#### The operation steps are as follows:

- In frequency mode, press Menu+1, the LCD displays:
- Press key Menu, the LCD displays:
- Press key ▲ or ▼ to choose your desired step frequency. You can set 2.5/5.0/6.25/10.0/12.5/25.0KHz step frequency.
- After setting, press key Menu to confirm, and then press key PTT or Exit to standby.

#### ▲ NOTE

- In channel mode, this function is invalid.



## FUNCTION OPERATION AND DESCRIPTION (The following description is without voice prompt.)

### ▶ Output Power (TXP) —Menu No.2

- This function can choose High/Low output power.

#### The operation steps are as follows:

- In frequency or channel mode, press Menu+2, the LCD displays:
- Press key Menu, the LCD displays:
- Press key Menu, and then press key ▲ or ▼ to choose. High: 5W, Low: 1W.
- After setting, press key Menu to confirm, and then press key PTT or Exit to standby.

#### ▲ NOTE

- Selecting high output power can improve the call quality, low output power can reduce radiation and the battery capacity loss. In channel mode, press fast key "#" to switch between high and low output power.

### ▶ Battery Saving (SAVE) —Menu No.3

- This function is mainly to save battery capacity when the radio is standby.

#### The operation steps are as follows:

- In frequency or channel mode, press Menu+3, the LCD displays:
- Press key Menu, and then press key ▲ or ▼ to choose battery saving function. The LCD displays:
- There are five kinds of mode. ①OFF ②1: 1 ③1: 2 ④1: 3 ⑤1: 4 Example: 1: 1(1s' working, 1s' battery saving) 1: 2 (1s' working, 2s' battery saving)
- After setting, press key Menu to confirm, and then press key PTT or Exit to standby.

#### ▲ NOTE

- If you choose OFF, the radio is not battery saving. In general, we suggest you choose 1:1.



FUNCTION OPERATION AND DESCRIPTION (The following description is without voice prompt.)

#### ④ VOX Function (VOX) —Menu No.4

- When this function is on, the system will recognize your talking to the microphone and then it will automatically shift to transmitting mode without manual operation (This function is useful for earphone users).

The operation steps are as follows:

- In frequency or channel mode, press Menu+4, the LCD displays:
- Press key Menu, and then press key ▲ or ▼ to choose VOX level. The LCD displays: There are (OFF-10) levels. OFF:OFF 10: Lowest level 1: Highest level
- After setting, press key Menu to confirm, and then press key PTT or Exit to standby. The LCD displays:

#### ⚠ NOTE

- ⊙ The higher level is, the higher sensitivity of microphone is. This function is invalid in scanning and FM radio mode.

#### ④ Wide/Narrow Bandwidth (W / N) —Menu No.5

- This function is used to set the working bandwidth of the radio.

The operation steps are as follows:

- In frequency mode, press Menu+5, the LCD displays:
- Press key Menu, and then press key ▲ or ▼ to choose wide or narrow bandwidth. The LCD displays: WIDE: 25KHz NARR: 12.5 KHz
- After setting, press key Menu to confirm, and then press key PTT or Exit to standby.

#### ⚠ NOTE

- ⊙ The radio normally use wide band. In channel mode, this function is invalid.



FUNCTION OPERATION AND DESCRIPTION (The following description is without voice prompt.)

#### ④ Auto Backlight (ABR) —Menu No.6

- This function can adjust the auto off time after radio display backlight is on.

The operation steps are as follows:

- In frequency or channel mode, press Menu+6, the LCD displays:
- Press key Menu, and then press key ▲ or ▼ to choose the backlight display time(1-5s). The LCD displays:
- After setting, press key Menu to confirm, and then press key PTT or Exit to standby.

#### ⚠ NOTE

- ⊙ We suggest you set 4-5 levels.

#### ④ Dual-watch Operation (TDR) —Menu No.7

- When this function is on, you may receive the signal of channel A and channel B at the same time. If any AB channel or frequency receives signal, “▲” will glitter on corresponding channel or frequency. Example: Channel A: 460.125MHz, Channel B: 151.235 MHz, The LCD displays: or

The operation steps are as follows:

- In standby mode, press Menu+7, the LCD displays:
- Press key Menu, and then press key ▲ or ▼ to choose ON, the LCD displays:
- After setting, press key Menu to confirm, and then press key PTT or Exit to standby. The LCD displays:

#### ⚠ NOTE

- ⊙ In dual-watch operation mode, you can change the parameter of AB channel or frequency freely.



FUNCTION OPERATION AND DESCRIPTION (The following description is without voice prompt.)

### Keypad Sound Reminding (BEEP) —Menu No.8

- This function is to set the reminding sound. It will beep when you press keypad.

The operation steps are as follows:

- In frequency or channel mode, press Menu+8, the LCD displays:
- Press key Menu, and then press key ▲ or ▼ to choose ON, the LCD displays:
- After setting, press key Menu to confirm, and then press key PTT or Exit to standby.

### Time-Out-Timer (TOT) —Menu No.9

- This function is to limit the calling time, the radio will stop transmitting and then launch voice if it transmits over setted time.

Example, if you want to set time limit for 15s. The operation steps are as follows:

- In frequency or channel mode, press Menu+9, the LCD displays:
- Press key Menu, and then press key ▲ or ▼ to choose 15s, The LCD displays:
- After setting, press key Menu to confirm, and then press key PTT or Exit to standby.



FUNCTION OPERATION AND DESCRIPTION (The following description is without voice prompt.)

### Receiving DCS (R--DCS) —Menu No.10

- Using this function can set your privacy and prevent disturbance from others or match with the code of other radios.

The operation steps are as follows:

- In frequency mode, press Menu+10, the LCD displays:
- Press key Menu, and then press key ▲ or ▼ to choose. The LCD displays:
- After setting, press key Menu to confirm, and then press key PTT or Exit to standby.  
The LCD displays:

#### NOTE

Ⓞ There are 208 groups of normal and inverse DCS in this radio. [see attached list (2)] This function is invalid in channel mode.

### Receiving CTCSS (R--CTCS) —Menu No.11

- Using this function can set your privacy and prevent disturbance from others or match with the code of other radios.

The operation steps are as follows:

- In frequency mode, press Menu+11, the LCD displays:
- Press key Menu, and then press key ▲ or ▼ to choose from 67.0—254.1Hz. The LCD displays:
- After setting, press key Menu to confirm, and then press key PTT or Exit to standby.  
The LCD displays:

#### NOTE

Ⓞ There are 50 groups of CTCSS. [see attached list (1)] . This function is invalid in channel mode.



FUNCTION OPERATION AND DESCRIPTION (The following description is without voice prompt.)

▶ Transmitting DCS (T--DCS) ——Menu No.12

- Using this function can set your privacy and prevent disturbance from others or match with the code of other radios.

The operation steps are as follows:

- In frequency mode, press Menu+12, the LCD displays:
- Press key Menu, and then press key ▲ or ▼ to choose, the LCD displays:
- After setting, press key Menu to confirm, and then press key PTT or Exit to standby.

The LCD displays:

▲ NOTE

○ There are 208 groups of normal and inverse DCS in this radio. [see attached list (2)] This function is invalid in channel mode.

▶ Transmitting CTCSS (T--CTCS) ——Menu No.13

- Using this function can set your privacy and prevent disturbance from others or match with the code of other radios.

The operation steps are as follows:

- In frequency mode, press Menu+13, the LCD displays:
- Press key Menu, and then press key ▲ or ▼ to choose, the LCD displays:
- After setting, press key Menu to confirm, and then press key PTT or Exit to standby.

The LCD displays:

▲ NOTE

○ There are 50 groups CTCSS. [See attached list (1)] This function is invalid in channel mode.



FUNCTION OPERATION AND DESCRIPTION (The following description is without voice prompt.)

▶ Voice Reminding (VOICE) ——Menu No.14

- It will voice remind you when you operate the radio. It's convenient for users.

The operation steps are as follows:

- In frequency or channel mode, press Menu+14, the LCD displays:
- Press key Menu, and then press key ▲ or ▼ to choose, the LCD displays:
- After setting, press key Menu to confirm, and then press key PTT or Exit to standby.

▶ ANI-ID (ANI-ID) ——Menu No.15

- ANI-ID can check out the code of your radio. This function can just be operated by program software, it can set 1-5 bit digit code.

**Example: The software set the ID code as 88888. The operation steps are as follows:**

- In frequency or channel mode, press Menu+15. the LCD displays:
- After searching, press key Menu to confirm, and then press key PTT or Exit to standby.



FUNCTION OPERATION AND DESCRIPTION (The following description is without voice prompt.)

### DTMFST (DTMFST) —Menu No.16

- This function is that when the radio transmits, the recipient can hear the DTMF and ANI-ID code issued by the radio.

The operation steps are as follows:

- In frequency or channel mode, press Menu+16, the LCD displays:
- Press key Menu and then press key ▲ or ▼ to choose, the LCD displays:
  - Choose mode: OFF: OFF
  - DT-ST: When transmitting, manually press keypads to make DTMF sound.
  - ANI-ST: When transmitting, it automatically makes DTMF sound.
  - DT+ANI: When transmitting, manually press keypads or automatically makes DTMF sound.
- After setting, press key Menu to confirm, then press PTT or Exit to standby.

#### NOTE

- Select "OFF" when using in case to affect the radio.

### Signal Code (S-CODE) —Menu No.17

- This function is to set radio signal code, it can set 1-15 groups. This function can just be set by program software.

The operation steps are as follows:

- In frequency or channel mode, press Menu+17, the LCD displays:
- Press key Menu, and then press key ▲ or ▼ to choose, the LCD displays:
- After setting, press key Menu to confirm, and then press key PTT or Exit to standby.

#### NOTE

- Do not use this function if not necessary in case to affect the radio.



FUNCTION OPERATION AND DESCRIPTION (The following description is without voice prompt.)

### Scan Resumed Mode (SC-REV) —Menu No.18

- This function can scan activities from other radios' frequencies or channels. You can select the scan mode according to your request.

The operation steps are as follows:

- In frequency or channel mode, press Menu+18, the LCD displays:
- Press key Menu, and then press key ▲ or ▼ to choose, the LCD displays: 

There are three ways of scanning.

  - TO: Time scanning, continue to scan after searching signal for 5s.
  - CO: Carrier scanning, when it searches the signal, it continues to scan after the signal disappears.
  - SE: Search scanning, stop scanning once searching the signal.
- After setting, press key Menu to confirm, and then press key PTT or Exit to standby.

### PTT ID (PTT-ID) —Menu No.19

- This function can set the sound of sending PTT-ID when you press key PTT or release it.

The operation steps are as follows:

- In frequency or channel mode, press Menu+19, the LCD displays:
- Press key Menu, and then press key ▲ or ▼ to choose, the LCD displays: 

There are four kinds of mode:

  - OFF: not send.
  - BOT: Press PTT key to send code.(The PTT-ID is set by software)
  - EOT: Release PTT key to send code.
  - BOTH: Press or release PTT key to send code.
- After setting, press key Menu to confirm, and then press key PTT or Exit to standby.

#### NOTE

- Select "off" in normal use to avoid affecting the radio.



FUNCTION OPERATION AND DESCRIPTION (The following description is without voice prompt.)

### ▶ PTT ID Prolong Time (PTT-LT) ——Menu No.20

- This function is to set the prolong time of sending the radio's PTT-ID.

The operation steps are as follows:

- In frequency or channel mode, press Menu+20, the LCD displays:
- Press key Menu, and then press key ▲ or ▼ to choose, the LCD displays: (There are 0-30ms to choose)
- After setting, press key Menu to confirm, and then press key PTT or Exit to standby.

#### ▲ NOTE

- Select "0" in normal use to avoid affecting the radio.

### ▶ A Channel Display Mode (MDF-A) ——Menu No.21

- This function is to set the display mode of channel A.

The operation steps are as follows:

- In standby mode press Menu+21, the LCD displays:
- Press key Menu, and then press key ▲ or ▼ to choose, the LCD displays: Display modes: ① **FREQ:** Frequency + Channel No. ② **CH:** Channel No. ③ **NAME:** Channel Name

#### ▲ NOTE

- Channel name must be set by program software. It can edit any three numbers or characters.



FUNCTION OPERATION AND DESCRIPTION (The following description is without voice prompt.)

### ▶ B Channel Display Mode (MDF-B) ——Menu No.22

- This function is to set the display mode of channel B.

The operation steps are as follows:

- In standby mode, press Menu+22, the LCD displays:
- Press key Menu, and then press key ▲ or ▼ to choose, the LCD displays: Display modes: ① **FREQ:** Frequency + Channel No. ② **CH:** CH: ③ **NAME:** Channel Name

#### ▲ NOTE

- Channel name must be set by program software. It can edit any three numbers or characters.

- After setting, press key Menu to confirm, and then press key PTT or Exit to standby.

### ▶ Busy Channel Lock (BCL) ——Menu No.23

- When this function is on, it may prevent other radios' interference. If the selected channel or frequency is being used by other radios, when you press key PTT, the radio you use can not transmit. It can transmit only when the station can not receive any signals.

The operation steps are as follows:

- In standby mode, press Menu+23, the LCD displays:
- Press key Menu, and then press key ▲ or ▼ to choose, the LCD displays: ON: ON OFF: OFF
- After setting, press key Menu to confirm, and then press key PTT or Exit to standby.



FUNCTION OPERATION AND DESCRIPTION (The following description is without voice prompt.)

### Auto Keypad Lock (AUTOLK) —Menu No.24

- When power on, but the radio is not in the working mode, the keypad will be automatically locked after 15s.

The operation steps are as follows:

- In frequency or channel mode, press Menu+24, the LCD displays:
- Press key Menu, and then press key ▲ or ▼ to choose, the LCD displays: ON: ON OFF: OFF
- After setting, press key Menu to confirm, and then press key PTT or Exit to standby.  
If you set on, the LCD displays:

### Frequency Offset Direction Setting (SFT-D) —Menu No.25

- Using this function, you may set different receiving and transmitting frequencies. In general, it's used for repeater.

The operation steps are as follows:

- In frequency mode, press Menu+25, the LCD displays:
- Press key Menu, and then press key ▲ or ▼ to choose, the LCD displays: The frequency deviation mode:
  - Transmitting frequency higher than receiving frequency (+) ;
  - Transmitting frequency lower than receiving frequency (-) ;
  - OFF
- After setting, press key Menu to confirm, and then press key PTT or Exit to standby.  
When you set the frequency deviation (+), the LCD displays:   
When you set the frequency deviation (-), the LCD displays:

#### NOTE

You should set different frequency deviation according to the repeaters selected. This function is invalid in channel mode.



FUNCTION OPERATION AND DESCRIPTION (The following description is without voice prompt.)

### Frequency Deviation (OFFSET) —Menu No.26

- Using this function, you can set the deviation between receiving and transmitting frequency. In general, this function is used for repeater. The frequency deviation of this radio is: 0-69.990MHz.

The operation steps are as follows:

- In frequency mode, press Menu+26, the LCD displays:
- Press key Menu, and then input your desired deviation frequency.  
If you want to input the frequency deviation 5MHz, pls input numbers 0、5、0、0、0 directly.
- After setting, press key Menu to confirm, and then press key PTT or Exit to standby.

#### NOTE

Setting the frequency offset direction. (See Menu No.25)

### Channel Store (MEM-CH) —Menu No.27

- When the radio is in frequency working mode or standby mode, input the desired frequency or parameters directly.

The operation steps are as follows:

- In frequency mode, press Menu+27, the LCD displays:
- Press key Menu, and then press key ▲ or ▼ to choose channel number, or you can input your desired channel number directly. For example, if you want to input No. 25 channel, pls input number 0、2、5 directly.
- After setting, press key Menu to confirm, and then press key PTT or Exit to standby.  
Example: Channel 1 (Same frequency) Receiving frequency: 465.875 MHz CTCSS: 71.9 Hz  
Transmitting frequency: 465.875 MHz CTCSS: 71.9 Hz  
Channel 2 (different frequency) Receiving frequency: 465.575 MHz  
Transmitting frequency: 460.575 MHz CTCSS: 88.5 Hz



First, storing channel 1 :

- In frequency mode, input number 4, 6, 5, 8, 7, 5.
- Press Menu+11, the LCD displays:
- Press key Menu, and then press key ▲ or ▼ to adjust to 71.9 Hz, the LCD displays:
- After setting, press key Menu to confirm, and then press key PTT or Exit to standby. The LCD displays:
- Press key Menu+13, the LCD displays:
- Press key Menu, and then press key ▲ or ▼ to adjust to 71.9 Hz, the LCD displays:
- After setting, press key Menu to confirm, and then press key PTT or Exit to standby. The LCD displays:
- Press Menu+27, the LCD displays:
- Press key Menu, and then press ▲ 001 channel or input number 0, 0, 1 directly, the LCD displays:
- After setting, press key Menu to confirm, and then press key PTT or Exit to standby.

Secondly, storing channel 2: (Transmitting frequency is 5MHz lower than receiving frequency.)

- In frequency mode, input number 4, 6, 5, 5, 7, 5.
- Press Menu+13, the LCD displays:
- Press key Menu, and then press key ▲ or ▼ to adjust to 88.5 Hz, the LCD displays:
- After setting, press key Menu to confirm, and then press key PTT or Exit to standby. After transmitting, the LCD displays:
- Press Menu+25, the LCD displays:
- Press key Menu, and then press key ▲ or ▼ to choose, the LCD displays:
- After setting, press key Menu to confirm, and then press key PTT or Exit to standby. The LCD displays:
- Press Menu+26, the LCD displays:
- Press key Menu, then input number: 0, 5, 0, 0, 0
- Press Menu+27, the LCD displays:
- Press key Menu, and then press key ▲ or ▼ to choose No.2 channel or input number 0,0, 2 directly. The LCD displays:
- After setting, press key Menu to confirm, and then press key PTT or Exit to standby.
- Press key VFO/MR to channel mode, the LCD displays:

Display modes see Menu No.21 and Menu No.22.

ⓘ Pls check the channel you store has the original channel or not, if does, you need to delete it before channel storing. (Channel delete see Menu No.28)



FUNCTION OPERATION AND DESCRIPTION (The following description is without voice prompt.)

### ▶ Channel Delete (DEL-CH) —Menu No.28

- This function is used to delete channels and information of the radio.

#### Example: Delete channel 2

- In frequency or channel mode, the LCD displays:
- Press key Menu, and then press key ▲ or ▼ to adjust channel 002 or input number 0,0, 2 directly. The LCD displays:
- After setting, press key Menu to confirm, and then press key PTT or Exit to standby.

#### ⚠ NOTE

ⓘ Please correctly choose the channel you want to delete in case to restorage and unnecessary trouble. With display CH-\*\*\* means there is storage channel, and then can be deleted.

### ▶ Standby Backlight (WT-LED) —Menu No.29

- You can choose the color of backlight when the radio is standby.

#### The operation steps are as follows:

- In frequency or channel mode, press Menu+29, the LCD displays:
  - Press key Menu, and then press key ▲ or ▼ to choose, the LCD displays:
- There are four options: OFF  
GREEN  
PURPLE  
SKY BLUE
- After setting, press key Menu to confirm, and then press key PTT or Exit to standby.





FUNCTION OPERATION AND DESCRIPTION (The following description is without voice prompt.)

▶ RX Backlight (RX-LED) ——Menu No.30

- You can choose the color of backlight when the radio is receiving.

The operation steps are as follows:

- In frequency or channel mode, press Menu+30, the LCD displays: 
- Press key Menu, and then press key ▲ or ▼ to choose, the LCD displays: 



There are four selection: OFF:  
GREEN  
PURPLE  
SKY BLUE

- After setting, press key Menu to confirm, and then press key PTT or Exit to standby.

▶ TX Backlight (TX-LED) ——Menu No.31

- You can choose the color of backlight when the radio is transmitting.

The operation steps are as follows:

- In frequency or channel mode, press Menu+31, the LCD displays: 
- Press key Menu, and then press key ▲ or ▼ to choose, the LCD displays: 

There are four options: OFF  
GREEN  
PURPLE  
SKY BLUE

- After setting, press key Menu to confirm, and then press key PTT or Exit to standby.





FUNCTION OPERATION AND DESCRIPTION (The following description is without voice prompt.)

▶ Alarm Mode (AL-MOD) ——Menu No.32

- This function can set tone alarm/code alarm/site alarm of the radio.

The operation steps are as follows:

- In frequency or channel mode, press Menu+32, the LCD displays: 
- Press key Menu, and then press key ▲ or ▼ to choose, the LCD displays: 

There are three options: SITE ALARM  
TONE ALARM  
CODE ALARM

- After setting, press key Menu to confirm, and then press key PTT or Exit to standby.

▶ Optional Signaling (OPTSIG) ——Menu No.33

- Set “OFF” , the DTMF shut down.
- Set “DTMF” , the DTMF open.



FUNCTION OPERATION AND DESCRIPTION (The following description is without voice prompt.)

### ④ Mute Mode Selection (SPMUTE) ——Menu No.34

- This function can be set up receiving decoding mode for radio.

**The operation steps are as follows:**

- On channel or frequency mode, press MENU + 34, the LCD displays:
- Press MENU, then press “▲” or “▼” to choose, the LCD displays:   
There are three options:  
QT: CTCSS conform to receive the call  
QT+DT: CTCSS and DTMF conform to receive the call  
QT\*DT: CTCSS or DTMF conform to receive the call
- After setting, press key Menu to confirm, and then press key PTT or Exit to standby.

### ④ Tail Tone Elimination (STE) ——Menu No.35

- To eliminate the annoying audio generated by the other radio after the transmitter ends the communication.

**The operation steps are as follows:**

- In frequency or channel mode, press Menu+35, the LCD displays:
- Press key Menu, and then press key ▲ or ▼ to choose, the LCD displays:   
There are two options : ON  
OFF
- After setting, press key Menu to confirm, and then press key PTT or Exit to standby.



FUNCTION OPERATION AND DESCRIPTION (The following description is without voice prompt.)

### ④ Tail Tone Elimination When Through Repeater (RP-SET) ——Menu No.36

- This function is that when the radio is through the repeater, the transmitter release PTT to enter receiving condition. Because of the delay of the repeater, it will receive the noise from repeater to confirm if the repeater is working or not.

**The operation steps are as follows:**

- In frequency or channel mode, press Menu+36, the LCD displays:
- Press key Menu, and then press key ▲ or ▼ to choose, the LCD displays:   
OFF: OFF 1, 2, 3, 4, 5……10 for prolong time.
- After setting, press key Menu to confirm, and then press key PTT or Exit to standby.

#### ⚠ NOTE

- Pls close this function in normal use, lest affect your normal conversation.

### ④ Delay Time Of Tail Tone Elimination When Through Repeater (RPT-RL) ——Menu No.37

- This function is that when the radio use through repeater, the aim is to confirm if the repeater have transferred the signal.

**The operation steps are as follows:**

- In frequency or channel mode, press Menu+37, the LCD displays:
- Press key Menu, and then press key ▲ or ▼ to choose, the LCD displays:   
OFF: OFF 1, 2, 3, 4, 5……10 for prolong time.
- After setting, press key Menu to confirm, and then press key PTT or Exit to standby.

#### ⚠ NOTE

- Pls close this function in normal use, lest affect your normal conversation.



FUNCTION OPERATION AND DESCRIPTION (The following description is without voice prompt.)

▶ Displays When Power On (PONMSG) —Menu No.38

- This function can set the display mode when power on.

The operation steps are as follows:

1. In frequency or channel mode, press Menu+40, the LCD displays:
2. Press key Menu, and then press key ▲ or ▼ to choose, the LCD displays:
3. After setting, press key Menu to confirm, and then press key PTT or Exit to standby.
4. Setting FULL, the LCD displays: ; Setting MSG, the LCD displays:

▶ Call End Warning Tone (ROGER) —Menu No.39

- This function is to make receptor hear a beep when conversation ends.

The operation steps are as follows:

1. In frequency or channel mode, press Menu+39, the LCD displays:
2. Press key Menu, and then press key ▲ or ▼ to choose, the LCD displays:
3. After setting, press key Menu to confirm, and then press key PTT or Exit to standby.



FUNCTION OPERATION AND DESCRIPTION (The following description is without voice prompt.)

▶ Dual-watch Operation (TDR-AB) —Menu No.40

- The function is to set A band or B band is transmit band when in dual-watch state. It also can be used for cross band receiving and transmitting.

The operation steps are as follows:

1. In frequency or channel mode, press Menu+40, the LCD displays:
  2. Press key Menu, and then press key ▲ or ▼ to choose, the LCD displays:
- There are three options:  
 OFF: “▲” or “▼” will glitter on transmitting frequency band.  
 A band to transmit in dual-watch code  
 B band to transmit in dual-watch code

Example: The LCD displays:

- ① Choose A means 465.575MHz is the transmitting frequency band, 136.225MHz is the receiving frequency band.
- ② Conversely, choose B means 136.225 MHz is transmitting frequency band, 465.575MHz is receiving frequency band.
3. After setting, press key Menu to confirm, and then press key PTT or Exit to standby.

▶ Reset (RESET) —Menu No.41

- This function is to set Menu and channel initialization. You can set the desired function and parameter after reset.



FUNCTION OPERATION AND DESCRIPTION (The following description is without voice prompt.)

#### VFO-Menu initialization

1. In frequency or channel mode, press Menu+40, the LCD displays:
2. Press key Menu, and then press key ▲ or ▼ to choose VFO, and then press key Menu again, the LCD displays:
3. Press key Menu, the LCD displays:
4. Press key Menu to confirm and return to standby automatically.

#### ALL-Menu and channel initialization

1. In frequency or channel mode, press Menu+40, the LCD displays:
2. Press key Menu, and then press key ▲ or ▼ to choose ALL, and then press key Menu again, the LCD displays:
3. Press key Menu, the LCD displays:
4. Press key Menu to confirm and return to standby automatically.

#### ▶ Manually Lock the Keypads

This function can lock the keypads.

1. Press key “#” for more than 2s, the radio will be locked and the LCD displays:
2. Press key “#” for more than 2s to unlock.



FUNCTION OPERATION AND DESCRIPTION (The following description is without voice prompt.)

#### ▶ Receptor

- You can listen to the radio frequency, the frequency range is from 76-108 MHz

**The operation steps are as follows:**

1. In frequency or channel mode, tap call key, the LCD displays:
2. Press key ▲ or ▼ to adjust radio frequency manually or input known radio frequency.  
Example: 100.7MHz Input number 1, 0, 0, 7, 0, 0 directly.  
88.9MHz Input number 8, 8, 9, 0, 0 directly.
3. Repeatedly press “\*” key can be automatically adjusted to the radio station.
4. Tap call key to exit Receptor.

#### ⚠ NOTE

⊙ When listening to the radio, the frequency or channel of A/B receiving signal will automatically switch to the frequency or channel state for normal transmitting and receiving. And it will automatically switch to FM state when signal disappears.

#### ▶ Rapid Alert (ALARM)

- In frequency or channel mode, press CALL key for more than 2s for rapid alarm, the LCD displays:

#### ⚠ NOTE

⊙ Alarm mode see Menu No.32.



FUNCTION OPERATION AND DESCRIPTION (The following description is without voice prompt.)

### ▶ Jacklight

- This function is suitable for night lighting and warning light.  
Tap key MON to turn on night lighting. Operate it again to turn on warning light.  
Operate it again to turn it off.



### ▶ Monitor (MON)

- In the same frequency mode, it can monitor signal from the others.  
Press MON key for more than 2s to turn it on. Release MON key to turn it off.

### ▶ Cable Clone (COPING)

- This function can copy one radio's information to another one.

The operation steps are as follows:

1. Connect with the main-radio and sub-radio by cloning cable.
2. Press and hold MON to turn the radio on, the LCD displays: COPING. The red light of main-radio glitter and the green light of sub-radio glitter
3. When the red and green light do not glitter, the LCD of sub-radio displays:  or  it means it succeeded in cloning.

### ▶ Channel/Frequency Mode Conversion (VF0/MR)

- Tap VF0/MR key to switch between channel and frequency mode.

### ▶ TX 1750Hz Call Tone

- Press key PTT+BAND to send 1750Hz call tone (This function is for the repeater of European market) .



FUNCTION OPERATION AND DESCRIPTION (The following description is without voice prompt.)

### ▶ Reverse Function ( R )

- When you set different frequencies, tapping “\*” key can shift the transmitting and receiving frequency, the LCD displays: 

The operation steps are as follows:

1. As above picture the receiving frequency of channel A is 420.875MHz, the transmitting frequency is 425.875MHz.
2. Tap “\*” key, the receiving frequency is changed to 425.875MHz, the transmitting frequency is changed to 400.875MHz, the LCD displays: 

#### ▲ NOTE

- This function is invalid in the same frequency.

### ▶ Frequency Scanning

- This function can scan the frequency activity from other radios.

The operation steps are as follows:

1. In frequency mode, press key “\*” for more than 2s, it will frequency scan according to setted step frequency.
2. Press key ▲ or ▼ to change the direction of scanning.
3. Press any key to confirm after scanning the signal.

#### ▲ NOTE

- Scanning mode see Menu No.18



FUNCTION OPERATION AND DESCRIPTION (The following description is without voice prompt.)

### ▶ Channel Scanning

- This function can scan the frequency activity from other radios.

The operation steps are as follows:

1. In channel mode, press key “\*” for more than 2s, it can scan according to the channel you setted.
2. Press key ▲ or ▼ to change the direction of scanning.
3. Press any key to confirm after scanning the signal.

#### ▲ NOTE

- Scanning mode see Menu No.18

### ▶ Automatic Search Receptor

- This function can automatically search the FM radio frequency. The frequency range is from 76-108MHz

The operation steps are as follows:

1. In frequency or channel mode, tap call key, the LCD displays:
2. Repeatedly press “\*” key can automatically search the FM radio frequency.
3. Tap call key to exit FM.

#### ▲ NOTE

- When listening to the radio, the frequency or channel of A/B receiving signal will automatically switch to the frequency or channel state, and when normal transmit and receive signal disappears it will automatically switch to FM state. Manually search see Menu 42.



FUNCTION OPERATION AND DESCRIPTION (The following description is without voice prompt.)

### ▶ Search CTCSS/DCS Code

- Using this function may search and store the CTCSS/DCS code from other radios when in same frequency.

**Example: CTCSS code scanning; the transmitting frequency is 465.255MHz, CTCSS is 88.5Hz**  
The operation steps are as follows:

1. In frequency mode, press Menu+11, the LCD displays:
2. Press key Menu, the LCD displays:
3. Press key “\*” , the LCD displays:
4. When other radio transmits, the LCD displays: ,CT ▲glitter means the radio has entered scanning condition.
5. The CTCSS will in turn and fast move from 67.0-254.1MHz.
6. After searching the CTCSS code, the radio will beep and stop scanning.
7. After setting, press key MR/VFO to confirm and store, otherwise press key PTT or Exit to standby.

#### ▲ NOTE

- 1. The operation steps of DCS scanning is the same with CTCSS, except that it needs to press Menu+10 to enter scanning. 2. If CTCSS have not searched the code, you can search DCS mode.

### ▶ Cursor “▲” Conversion (A/B)

- Directly taping AB key can move the cursor up and down, you can modify or confirm the parameters of the frequency and channel where the cursor is.

### ▶ High/Low Power Fast Conversion

- In channel mode, tap “#” key to shift between high and low power.



## FUNCTION OPERATION AND DESCRIPTION (The following description is without voice prompt.)

### Stun/Kill/Revive

- This function can remote control other radios in these status: only receive without transmit, receive and transmit forbidden, activate it back to normal use. Stun: only receive without transmit, Kill: receive and transmit forbidden, Revive: activate it back to normal use.

**The radio has 19 keypads, including digit 0-9, \*, # , function keys and ABCD letter keys. (Details please refer to digit keypads basic operation in page 11). Implementation step: press PTT to send both the ANI ID of sub-radio and remote code to realize the function, each code is 5 digits.**

#### Operating steps:

- Please click "Edit" in PC program software, then click "DTMF code" , finally fill custom 5 digit code (Stun/Kill/Revive) in the parameter frame. There is "troop call code" in option box and choose code "A" (troop call code is universal character of ANI code), finally write into radio. **(Note:** Troop call code can be ABCD\*#)

**For example: Stun code AB\*88 Kill code CD120 Revive code A8A8A**

- The ANI code of sub-radio should be set by computer programming, please write user-defined ANI code in "ID CODE" frame after press "Edit" and "DTMF" .(Details please refer to Menu 15 in page 30) **Note:** The ANI code of each radio is independent.

**For example: 1st sub-radio: 10026 2nd sub-radio: 10088 3rd sub-radio: 10033 4th sub-radio: 222333**

- Open DTMF in menu 33 and confirm it. When DTMF is working, you should choose "QT" or "QT&DT" in menu 34 to realize normal talk. CTCSS and DCS also must stay the same.
- If you want to remote stun 2nd sub-radio, press PTT key of main-radio and input ANI code of 2nd sub-radio "10088" and stun code "AB\*88" by keypad (Note: 10088AB\*88), then the 2nd sub-radio can only receive without transmit. If you want to recover it in normal working, press PTT key of main-radio and input ANI code of 2nd sub-radio "10088" and revive code "A8A8A" by keypad **(Note:** 10088A8A8A), the 2nd sub-radio will return in normal use.
- If you want to remote stun 1st, 2nd, 3rd sub-radios at the same time, press PTT key of main-radio, then input first



## FUNCTION OPERATION AND DESCRIPTION (The following description is without voice prompt.)

three same digits of ANI code of 3 sub-radio and two digits of troop call "100AA" and stun code "A8A8A" by keypad **(Note:** 100AAAB\*88), finally the sub-radios can only receive without transmit. If you want to recover them in normal working, press PTT key of main-radio and input first three same digits of ANI code of 3 sub-radio and two digits of troop call "100AA" and revive code "A8A8A" **(Note:** 100AAA8A8A), the sub-radios will return in normal use.

- If you want to stun all the sub-radios at the same time, press PTT key of main-radio, then input troop code "AAAAA" and stun code "AB\*88" (Note: AAAAAAB\*88), finally all the sub-radios can only receive without transmit. If you want to recover them in normal working, press PTT key of main-radio, then input troop call of sub-radios "AAAAA" and revive code "A8A8A" **(Note:** AAAAAA8A8A), finally all the sub-radios will return in normal use.
- In order the radio will be stunned or killed randomly, there is a "controlled" in the option box of DTMF in the software, if you select "✓" , it mean the radio will be stunned or killed accordingly, if do not select "✓" , it mean the radio can not be controlled to entry state of stun or kill.

#### NOTE

Note: You should close PTT-ID code sending when operate function of stun, kill or revive, it's better to set the code mixed with ABCD\*#.

### Single call/Group call/Troop call

- The function can realize single call, group call and troop call in same frequency by DTMF and PTT-ID. **The radio has 19 keypads, including digit 0-9, \*, # , function keys and ABCD letter keys. (Details please refer to digit keypads basic operation in page 11). Implementation step: please send own ANI code firstly, then send adverse ANI code, you should send two codes to activate communication, each code is 5 digits.**

**Operating steps in frequency mode:**  
FUNCTION OPERATION AND DESCRIPTION



## FUNCTION OPERATION AND DESCRIPTION (The following description is without voice prompt.)

1. ANI code can be set by PC programming only, you can input user-defined code in "ID CODE" frame after click "DTMF" and "Edit" in toolbar. (Details please refer to Menu 15 in page 30) **Note:** The ANI code of each radio is independent.

**For example: 1st sub-radio: 10026 2nd sub-radio: 10088 3rd sub-radio: 22233 4th sub-radio: 88888**

2. Set up parameters in each radio, in Menu 17 (Details in page 31), select one of fifteen groups ( **Note:** 15 groups signal code corresponds to DTMF code in software) and confirm it. In Menu 19, open up PTT-ID and notice the delay time of code sending (Details in page 33) , then confirm it. In Menu 33, open up DTMF (Details in page 40) and confirm it. In Menu 34, set the mute type (details in page 41) and confirm it.
3. Single Call

We only want to call individually even if when all radios are set in the same frequency.

- a. If you want to call 1st sub-radio, press and hold the PTT key, the radio will send PTT-ID automatically when calling, then input the ID code "10026" of 1st sub-radio (**Note:** 8888810026) , the single call of 1st sub-radio is successfully activated.
- b. If you don't want to open PTT-ID, press and hold PTT key and input own AI code "88888" and AI code "10026" of 1st sub-radio (**Note:** 8888810026), the single call of 1st sub-radio is successfully activated.
- c. You should press PTT key of 1st sub-radio to send the confirm message to main radio after the single call is activated, finally the two radios can work with each other. If the activate time is 5s, it mean you should resend the code to activate it when the radio standby more than 5s.You can set up the activate time in frame "1-15s launch overtime warning" in DTMF side tone after clicking "option box" and "Edit" in PC program software.

### 4. Group Call

For example: set two radios as a group call when many radios are in the same frequency.

- a. There is "troop call code" in option box and choose code "A" (troop call code is universal character of ANI code) after click "Edit" and "DTMF" in toolbar, finally write it into radio. (Troop call code can be mixed with ABCD\*#)



## FUNCTION OPERATION AND DESCRIPTION (The following description is without voice prompt.)

- b. When you want to make a group call, press and hold PTT key of main radio to send the own PTT-ID code, then input the first three same digits of 1st sub-radio and 2nd sub-radio and 2 digit group call code 100AA (**Note:** 88888100AA) by keypad, the group call of 1st sub-radio and 2nd sub-radio is successfully activated.
- c. If you don't want to open PTT-ID, press and hold PTT key and input own AI code "88888" , then input the first three same digits of 1st sub-radio and 2nd sub-radio and 2 digit group call code 100AA (**Note:** 88888100AA) by keypad, the group call of 1st sub-radio and 2nd sub-radio is successfully activated.
- d. You should press PTT key of either 1st sub-radio or 2nd sub-radio to send the confirm message to main radio after the group call is activated, finally the three radios can work with each other. If the activate time is 5s, it mean you should resend the code to activate it when the radio standby more than 5s.You can set up the activate time in frame "1-15s launch overtime warning" in DTMF side tone after clicking "option box" and "Edit" in PC program software.

### 5. Troop Call

For example: we can set the troop call when many radios are in the same frequency.

- a. There is "troop call code" in option box and choose code "A" (troop call code is universal character of ANI code) after click "Edit" and "DTMF" in toolbar, finally write it into radio. (Troop call code can be mixed with ABCD\*#)
- b. When you want to make a troop call, press and hold PTT key of main radio to send the own PTT-ID code, then input the five digits troop call code "AAAAA" (Note: 88888AAAAA), the troop call is successfully activated.
- c. If you don't want to open PTT-ID, press and hold PTT key and input own AI code "88888" , then input the five digits troop call code "AAAAA" (Note: 88888AAAAA), the troop call is successfully
- d. You should press PTT key of any sub-radios to send the confirm message to main radio after the troop call is activated, finally all the radios can work with each other. If the activate time is 5s, it mean you should resend the code to activate it when the radio standby more than 5s.You can set up the activate time in frame "1-15s launch



## FUNCTION OPERATION AND DESCRIPTION (The following description is without voice prompt.)

overtime warning” in DTMF side tone after clicking “option box” and “Edit” in PC program software.

### 1. Single call/Group call/Troop call in channel mode

1. If you want to make single call/group call/troop call in channel mode, please select Menu 27 to store channel (details please refer to page 36) or set all the above parameters in PC programming and write them into radios, corresponding to the above a, b, c, d to realize function after finish the above A and B operation steps accordingly.

### 2. Automatic Control of Single Call/Group call/Troop call

• It mean you can activate these function only by selecting the signal code and pressing PTT key, no need to use sending code.

#### Operating steps:

1. ANI code can be set by PC programming only, you can input user-defined code in “ID CODE” frame after click “DTMF” and “Edit” in toolbar. (Details please refer to Menu 15 in page 30) **Note:** The ANI code of each radio is independent.

**For example: 1st sub-radio: 10026 2nd sub-radio: 10088 3rd sub-radio: 22233 4th sub-radio: 88888**

2. There is “troop call code” in option box and choose code “A” (troop call code is universal character of ANI code), finally write into radio. (Troop call code can be ABCD\*#)

3. Steps to set 15 groups of signal code: please click “Edit” in toolbar and click “DTMF”, then input the AI code of 1st sub-radio, 2nd sub-radio and 3rd sub-radio to the corresponding 1, 2, 3 code group in DTMF frame, then input group code “100AA” to four groups and input troop code “AAAAA” to the five groups (Note: The signal code corresponds to DTMF code in PC software is in Menu 17, details please refer to page 31), finally write into the radio after edit.

Code Group Sending Code	
1	10026
2	10088
3	22233
4	100AA
5	AAAAA
6	
7	

For example:  
FUNCTION OPERATION AND DESCRIPTION

55



## FUNCTION OPERATION AND DESCRIPTION (The following description is without voice prompt.)

4. Parameters setting: select Menu 19, then open PTT-ID and set the delay time of code sending (Details please refer to page 33) and confirm it; select Menu 33, then open DTMF (Details please refer to page 40) and confirm it; select Menu 34 to set the silent mode and select QT+DT (Details please refer to page 41) and confirm it, finally the setting is finished.

5. If you want to make a single call to 1st sub-radio: in Menu 17 “signal code” (Details please refer to page 31) and select first group (Note: The signal code corresponds to DTMF code in PC software) and confirm it; press PTT key of main radio to transmit the own PTT-ID and adverse PTT-ID, the single call is activated successfully. If you want to call signal code of 2nd sub-radio and 3rd sub-radio please select corresponding second and third group.

6. If you want to make a group call to 1st sub-radio and 2nd sub-radio: in Menu 17 “signal code” (Details please refer to page 31) and select the fourth group (Note: The signal code corresponds to DTMF code in PC software) and confirm it; press PTT key of main radio to transmit the own PTT-ID and group call code, the group call is activated successfully.

7. If you want to make a troop call: in Menu 17 “signal code” (Details please refer to page 31) and select the fifth group (Note: The signal code corresponds to DTMF code in PC software) and confirm it; press PTT key of main radio to transmit the own PTT-ID and troop call code, the troop call is activated successfully.

8. You should press PTT key of any sub-radio to send the confirm message to main radio after the single call/group call/troop call is activated, finally all the radios can work with each other. If the activate time is 5s, it mean you should resend the code to activate it when the radio standby more than 5s. You can set up the activate time in frame “1-15s launch overtime warning” in DTMF side tone after clicking “option box” and “Edit” in PC program software.

#### ▲ NOTE

○ The function is only valid when PTT-ID is open.

FUNCTION OPERATION AND DESCRIPTION

56

**CTCSS**

01	67.0	11	94.8	21	131.8	31	171.3	41	203.5
02	69.3	12	97.4	22	136.5	32	173.8	42	206.5
03	71.9	13	100.0	23	141.3	33	177.3	43	210.7
04	74.4	14	103.5	24	146.2	34	179.9	44	218.1
05	77.0	15	107.2	25	151.4	35	183.6	45	225.7
06	79.7	16	110.9	26	156.7	36	186.2	46	229.1
07	82.5	17	114.8	27	159.8	37	189.9	47	233.6
08	85.4	18	118.8	28	162.2	39	192.8	48	241.8
09	88.5	19	123.0	29	165.5	39	196.6	49	250.3
10	91.5	20	127.3	30	167.9	40	199.5	50	254.1

**DCS**

01	D023N	18	D115N	35	D212N	52	D306N	69	D431N	86	D546N
02	D025N	19	D116N	36	D223N	53	D311N	70	D432N	87	D565N
03	D026N	20	D122N	37	D225N	54	D315N	71	D445N	88	D606N
04	D031N	21	D125N	39	D226N	55	D325N	72	D446N	89	D612N
05	D032N	22	D131N	39	D243N	56	D331N	73	D452N	90	D624N
06	D036N	23	D132N	40	D244N	57	D332N	74	D454N	91	D627N
07	D043N	24	D134N	41	D245N	58	D343N	75	D455N	92	D631N
08	D047N	25	D143N	42	D246N	59	D346N	76	D462N	93	D632N
09	D051N	26	D145N	43	D251N	60	D351N	77	D464N	94	D654N
10	D053N	27	D152N	44	D252N	61	D356N	78	D465N	95	D662N
11	D054N	28	D155N	45	D255N	62	D364N	79	D466N	96	D664N
12	D065N	29	D156N	46	D261N	63	D365N	80	D503N	97	D703N
13	D071N	30	D162N	47	D263N	64	D371N	81	D506N	98	D712N
14	D072N	31	D165N	48	D265N	65	D411N	82	D516N	99	D723N
15	D073N	32	D172N	49	D266N	66	D412N	83	D523N	100	D731N
16	D074N	33	D174N	50	D271N	67	D413N	84	D526N	101	D732N
17	D114N	34	D205N	51	D274N	68	D423N	85	D532N	102	D734N



DCS											
103	D743N	121	D114I	139	D212I	157	D311I	175	D445I	193	D612I
104	D754N	122	D115I	140	D223I	158	D315I	176	D446I	194	D624I
105	D023I	123	D116I	141	D225I	159	D325I	177	D452I	195	D627I
106	D025I	124	D122I	142	D226I	160	D331I	178	D454I	196	D631I
107	D026I	125	D125I	143	D243I	161	D332I	179	D455I	197	D632I
108	D031I	126	D131I	144	D244I	162	D343I	180	D462I	198	D654I
109	D032I	127	D132I	145	D245I	163	D346I	181	D464I	199	D662I
110	D036I	128	D134I	146	D246I	164	D351I	182	D465I	200	D664I
111	D043I	129	D143I	147	D251I	165	D356I	183	D466I	201	D703I
112	D047I	130	D145I	148	D252I	166	D364I	184	D503I	202	D712I
113	D051I	131	D152	149	D255I	167	D365I	185	D506I	203	D723I
114	D053I	132	D155I	150	D261I	168	D371I	186	D516I	204	D731I
115	D054I	133	D156I	151	D263I	169	D411I	187	D523I	205	D732I
116	D065I	134	D162I	152	D265I	170	D412I	188	D526I	206	D734I
117	D071I	135	D165I	153	D266I	171	D413I	189	D532I	207	D743I
118	D072I	136	D172I	154	D271I	172	D423I	190	D546I	208	D754I
119	D073I	137	D174II	155	D274I	173	D431I	191	D565I		
120	D074I	138	D205I	156	D306I	174	D432I	192	D606I		



SPECIFICATIONS			
GENERAL			
Frequency range	VHF:144~146MHz, UHF:430~440MHz FM:76-108 MHz (only in reception)		
Rated voltage	DC7.2V(Rechargeable Li-ion battery)		
Memory channel	128 channels		
Antenna impedance	50Ω		
Working manner	Same frequency single operation or different frequency single operation		
Step frequency	2.5/5/6.25/10/12.5/25 khz		
Frequency sensitivity	±2.5ppm		
Working temperature	-20°C~+50°C		
Battery capacity	1600Mah		
Dimensions	122mmX63mmX36mm		
TRANSMITTER		RECEIVER	
Output power	5W	Sensitivity	-122dBm(12dB SINAD)
Modulation mode(W/N)	16KΦF3E , 11KΦF3E	Modulation band	5KHz
Maximum frequency deviation(W/N)	<5K/<2.5KHz	Audio power	1W
Supurious radiation	<7.5μW	Audio distortion	<10%
Adjacent channel selectivity	≤-65dB/≤-60dB	Receive current	≤380mA
Emission current	≤0.4A	Intermodulation(W/N)	≥65dB ≥60dB
CTCSS/DCS frequency deviation(W/N)	0.7KHz±0.1KHz/0.4KHz±0.1KHz	Adjacent channel selectivity	≥65dB ≥60dB
Modulation sensitivity	8~12mV	Spurious rejection	≥65dB
Signal-noise rate(W/N)	≥-45dB/≥-40dB		

© All stated specifications are subject to change without notice or obligation



# CRT

## DECLARATION OF CONFORMITY



We hereby declare under our responsibility that the product

Matériel: Handheld transceiver

Brand : CRT

Model : FP 00

Description : Ham Radio

144-146 MHz/430- 440 MHz

Satisfies all the technical regulations applicable to the product within the scope of directive RED 2014/53/EU and european standards

EN 60950-1 :2006+A11 :2009+A1 :2010+A12 :2011+A2 :2013

EN 62209-2 :2010

EN50566 :2013

EN 301 489-1 V2.2.0

EN 301 489-15 V2.2.0

EN 55032 :2015/AC :2016

EN 55020 :2007/A11 :2011

EN 301 783 V2.1.1.

EN 303 345 V1.1.7

The was approved in the CEPT countries and those non CEPT countries that  
Implement the CEPT regulation TR 61/01

C.R.T. FRANCE INTERNATIONAL S.A.R.L.

Route de Pagny 21250 SEURRE FRANCE

Capital de 762 500 euros

Tél. 03 80 26 91 91 Fax : 03 80 26 91 00

Email : superstar@crtfrance.com

Web site : www.crtfrance.com

Mr CELESTRANO PHILIPPE

Manager

LE 02/01/2018



ISO  
9001  
QUALITY  
ASSURANCE





## CONDITIONS OF GUARANTEE

This transceiver **CRT SUPERSTAR** is guaranteed on 2 years. Any abnormality of functioning must be indicated to your retailer, who will intervene or will send it to our technical service for control

The spare parts of our devices are the object of no sending under guarantee

### **Are excluded of the guarantee :**

- the damages caused by accidents, shocks, natural elements (lightning, thunderstorm, static electricity etc.)
- The transistors of power, the microphones, the fuses, the bad uses: badly adjusted antenna (too excessive), inversion of polarity, surge, bad connection etc. recognized by our technical service
- The interventions having modified the standards of approval of the device



## PROCEDURE ON RETURNING TO THE AFTER-SALES SERVICE CRT

- If you send back a radio under guarantee for repair: you pay the freight costs to go. CRT will pay the freight costs return. If the radio is not under guarantee postal charges are at your expense.

- each device must be sent accompanied with a photocopy of the invoice as well as with a descriptive note of the noticed defect

If our AFTER-SALES SERVICE estimates the repair more expensive than the value of the device, this one will send you an estimate which must have returned to him accepted or refused. If the estimate is refused, the device will have carriage forward returned.