

TCB-550

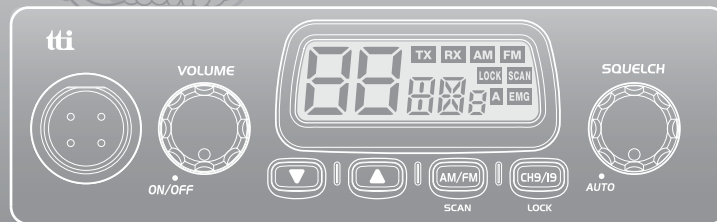

4W MOBILE CB TRANSCEIVER INSTRUCTION MANUAL



www.ttikorea.co.kr

CONTENTS

1. Introduction	3
2. Supplied Accessories	3
3. Installation	3
4. Transceiver Controls and Functions	6
1) Microphone Jack	6
2) Volume and Power On/Off Knob	6
3) LCD Display	6
4) Down Button	7
5) Up Button	7
6) AM/FM and Scan Button	8
7) Emergency/Calling & Lock Button	8
8) Squelch Control Knob	8
9) Antenna Connector	8
10) Power 13.2DC	8
11) EXT-SPK Jack	9
5. LCD Display	9
6. Microphone	9
7. Menu Setting Mode	10
8. How to Operate the Transceiver	11
9. Band Selection	11
10. Trouble Shooting	12
11. CE Declaration	13
12. Safety Requirement	13
13. Specification	14
14. Restrictions on the use	15
15. Frequency Table	16

1. Introduction

TCB-550 transceiver is designed to have a good performance in any conditions that the transceiver operates, using rugged build chassis, PCB's and components. This transceiver is also designed for users' convenience, implementing human ergonomics to locate the knobs and buttons in the proper places. The combination of well designed knobs and buttons as well as user friendly graphic layouts will lead users to quickly adapt themselves for the easy operation. The newly applied menu mode will make professional users more satisfactory with pleasure. The elegant and luxury blue LED light supporting the face design will go well with any vehicles.

This instruction manual has been designed to enable you to get the best use from your CB Transceiver, therefore you are recommended to take a few minutes to read this instruction manual before initial use of your CB Transceiver.

2. Supplied Accessories

Your transceiver is supplied with a full range of accessories to help you get started and virtually benefit from all the features straight away.

TCB-550 transceiver with Power cable	1 unit
Microphone with cord	1 unit
Radio mounting bracket	1 unit
Radio mounting thumb screw with rubber washer	2 pieces
Mounting screw with washer (for transceiver bracket)	3 pieces
Mounting screw with washer (for microphone bracket)	2 pieces
Microphone mounting bracket	1 piece

3. Installation

Plan the location of the transceiver and microphone first, which is most convenient for the operation. The transceiver should normally be mounted horizontally, but may be mounted vertically. The bracket supplied can be fitted above or below the case allowing the TCB-550 to be cradled by the bracket or suspended from it.

Consider that this location of the transceiver should not interfere with the driver and passengers. Choose a spot where the microphone and all controls are easily accessible.

- 1) Put the mounting bracket on the proper location where you are going to install.
- 2) Drill holes and fix mounting bracket on the location.
- 3) Connect the antenna cable plug to the standard receptacle on the transceiver, which is marked "ANT".

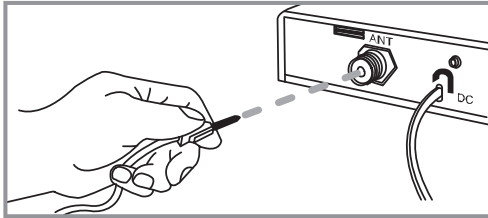

- 4) Connect the power cable directly to the vehicle battery or fuse box of the car. Be careful to make sure of the polarity of the battery first and connect the cable. (Red: Positive Pole(+), Black: Negative Pole(-). The same colours are shown on the battery and in the fuse box of the car.)
- 5) Mount the microphone bracket on one side of the transceiver, or near it using two screws included.
- 6) Connect the microphone to the transceiver's microphone receptacle. Now you are ready to operate the transceiver.

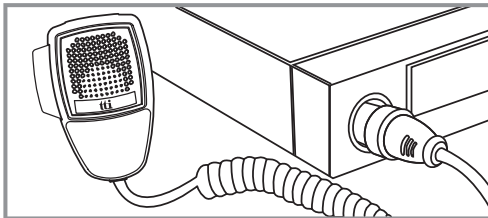

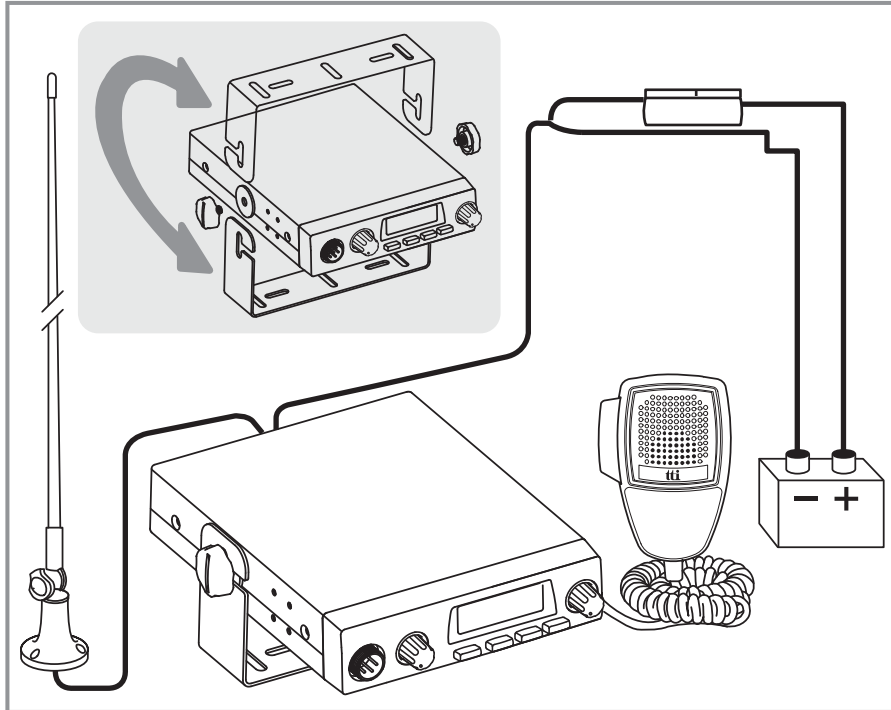

Installing An Antenna

It is very important to select a good quality high efficiency 27MHz antenna. A poor quality antenna or one not designed for the 27MHz band will give very poor performance and could cause damage to the transceiver.

- 1) Place the antenna as high as possible.
- 2) The longer the antenna is, normally the better is the performance of the transceiver.
- 3) Try to mount the antenna in the centre of the surface that you select.
- 4) Make sure that you have a solid metal-to-metal ground connection.
- 5) Be careful not to damage the cable during the installation.

Warning : Never try the operation of your transceiver before connecting a proper antenna in order not to cause any damage.

4. Transceiver Controls and Functions

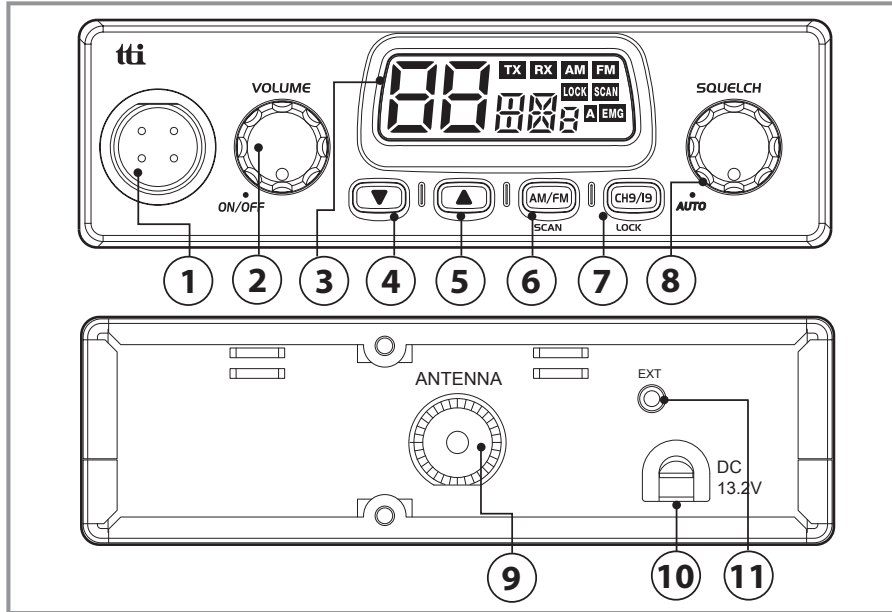

1) Microphone Jack

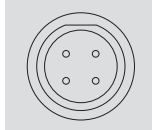

Insert the microphone into this jack. Use the guide for easy connection.

2) Volume and Power On/Off Knob

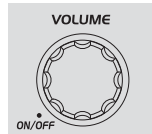

To switch on the transceiver turn this knob clockwise. After clicking sound the transceiver is switched on. The more you turn this knob clockwise, the bigger the audio sound grows.

3) LCD Display

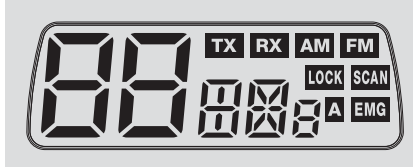

Most of the operational information is displayed. Please see item no. 5 for the details of information.

4) Down Button

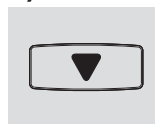

Press this button briefly to select the channel one by one that you like to use.

5) Up Button



Press this button briefly to select the channel one by one that you like to use.

6) AM/FM and Scan Button

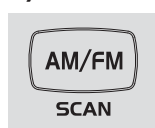

AM/FM In many a band mode like EU,I,D and etc. (where national regulations permit this) this button allows user to switch between AM and FM modes by momentarily pressing the button. When the transceiver is used in UK,UE or EC band mode, this button generates an error beep.

Scan : Press and hold this button to start scanning upward to catch any channels that are occupied by others.

To activate/deactivate the channel scan, press and hold the Scan button. The Scan icon will appear when the channel scan is active. Scanning will only stop when you deactivate the scan function.

The transceiver will scan through the whole transceiver channels. If your transceiver detects a valid signal the scan will pause for the period that has been set by the menu mode setting (continuously receiving or 1-99 seconds for scan receive time and immediate response or 1-99 seconds for scan delay time).

If you press the PTT button when your transceiver detects a signal, the radio will transmit on the same channel. Scanning will resume after the scan receive time and/or the scan delay time. Use the up/down buttons to resume scanning immediately.

If you press the PTT button during scanning, the radio will return to your original channel. Scanning will resume after the scan receive time and/or the scan delay time. Use the up/down buttons to resume scanning immediately.

Lock : Press this button for more than 2 seconds to activate and deactivate the keypad lock function. This function locks only the channel selector, AM/FM & Scan button. Other buttons and selectors work normal.

7) Emergency/Calling and Lock Button



Emergency/Calling Pressing this button momentarily once will lead you to the emergency channel, "CH 9"("CH 19" in some bands) and the EMG icon will be displayed. Pressing this button twice will lead you to the calling channel, "CH 19" ("CH 9" in some bands) will be displayed.

To return to the previous operation mode, momentarily press the emergency button again.

8) Squelch Control knob

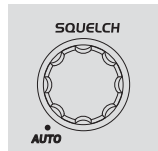

Auto Mode : Turn this knob counter-clockwise until you hear the sound. Your transceiver is in the Automatic squelch mode. This works better in FM mode than AM mode. If you are using AM mode, you are recommended to use the manual squelch mode.

Manual Mode : Turn this knob counter-clockwise until you hear the background noise (but before click sound to enter the automatic squelch mode) and then turn the knob a little clockwise until the noise disappears. In this way, you get the best receive sensitivity.

9) Antenna Connector

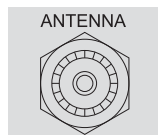

Insert the male connector of the antenna cable into this female antenna connector.

10) Power 13.2 DC



The power supply cable is connected to this port.

11) EXT-SPK Jack



Connecting a loud speaker to this port makes the built-in speaker turned off.

5. LCD Display

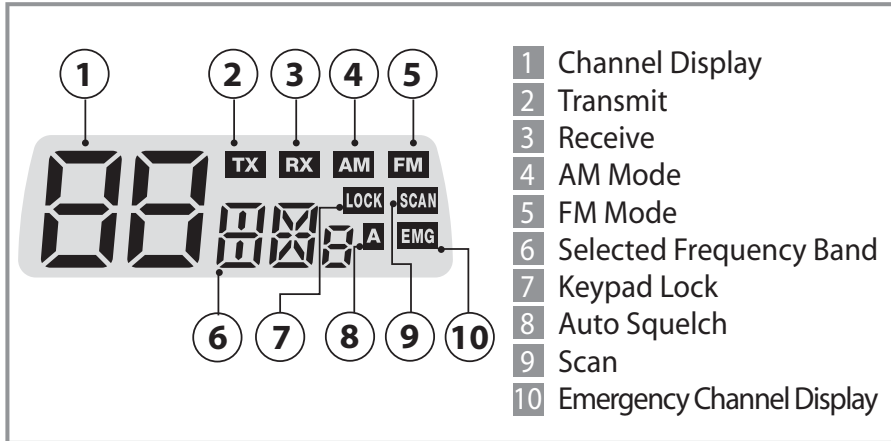

6. Microphone

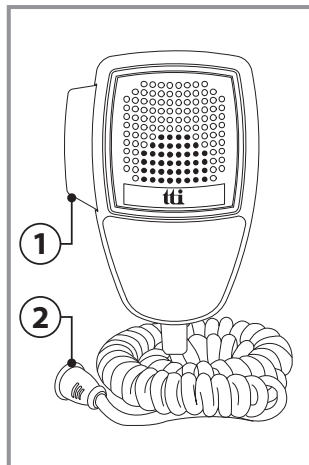

- 1 PTT Button : While pressing this button, you can transmit.
- 2 4 Pin Microphone Connector : Connect this to the microphone jack on the front panel of the transceiver.

7. Menu Setting Mode

Pressing the Emergency/Calling button, turn on the transceiver. The transceiver goes to the Menu Setting Mode, which has the following menu features. This menu setting mode allows you to program user preferences, activate features and use advanced functions.

Display	Functions	Settings
bp	Beep Tone	On(ON) / Off(OFF)
to	Time-out Timer	Off(OFF) and 1~99 Sec.
sr	Scan Receive Timer	Continue(LO) and 1-99 Sec.
sd	Scan Delay Timer (after Receiving signal)	Off(OFF) and 1~99 Sec.
bl	Backlight Dimmer	High(HI) / Low(LO)

Note :

1. Use the AM/FM button to selecte the main menu features such as Beep Tone, Time-out Timer, Scan Receive Timer, Scan Delay Timer and Backlight Dimmer.
2. Use the up/down buttons to select or change any value that you like to have while the values are blinking.
3. Press the PTT button of the Microphone to complete the selections and changes and return to the stand-by mode. Or the selections and changes will be automatically confirmed after 5 seconds of the selections and changes.

8. How to Operate the Transceiver

- 1) Make sure the microphone is connected to the microphone jack.
- 2) Make sure the power cable is connected properly.
- 3) Make sure the antenna is connected to the antenna receptacle.
- 4) It is better to put the squelch control knob turned fully counter-clockwise. (In case of the manual squelch mode)
- 5) Turn on the transceiver and control the volume level.
- 6) Adjust the squelch control knob to the optimum level.
- 7) Select your desired channel.
- 8) To transmit, press the PTT button and speak to the microphone.
- 9) Release the PTT button to receive.

9. Band Selection

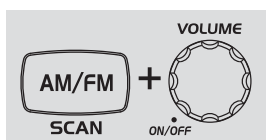

Pressing AM/FM button, turn on the transceiver. The LCD display offers you the band information. The band chart for each area is as follows.

To change the band, press the Up/Down buttons while the band information is blinking. Press the PTT button of the microphone, or wait for 5 seconds to complete the selection and go to the transmit and receive mode. This transceiver has "EC" band setting when it is shipped out from the factory.

Settings	Display	Band
EC	EC	Europe 40 Ch FM 4W
E	E	Spain 40 Ch AM/FM 4W
F	F	France 40 Ch FM 4W, 40 Ch AM 1W
PL	PL	Poland 40 Ch AM/FM 4W (Polish frequencies : 5KHz)

Settings	Display	Band
UK	UK	UK 40 Ch FM 4W (British Frequencies)
UE (EU/UK)	UE	UK 40 Ch FM 4W (British Frequencies) + CEPT 40 Ch FM 4W (EC)
I	I	Italy 40 Ch AM / FM 4W
I2	I2	Italy 34 Ch AM / FM 4W
D	d	Germany 80 Ch FM 4W, 12 Ch AM 1W
D2	d2	Germany 40 Ch FM 4W, 12 Ch AM 1W
EU	EU	Europe 40 Ch FM 4W, 40 Ch AM 1W

10. Trouble Shooting

If you experience problems with your TCB-550 transceiver, first check the power supply source. Poor connection of the power supply source can cause problems such as no transmission, no reception or poor reception, and weak or no sound. Ensure that the microphone and antenna are also well connected.

If this does not solve the problem, reset your transceiver as follows.

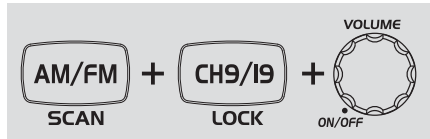

- 1) Switch off the transceiver.
- 2) Pressing the AM/FM button and the CH 9/19 button, switch on the transceiver.

This will reset the transceiver, so all the memories are erased and the parameters return to the initial factory setting.

This should fix most problems. In case of further difficulty, please consult your dealer or visit our website.

11. CE Declaration

CE 0700 CE versions of the TCB-550 which display the CE symbol on the product label, comply with the essential requirements of the European Radio and Telecommunication Terminal Directive 1999/5/CE.

- !** This warning symbol indicates that this equipment operates in non-harmonised frequency bands and/or may be subject to licensing conditions in the country of use. Be sure to check that you have the correct version of this radio or the correct programming of this radio, to comply with your national licensing requirements.

This unit can be used without license and charges in; Austria, Belgium, Bulgaria, Cyprus, Czech, Denmark, Estonia, Finland, France, Germany, Greece, Hungary, Iceland, Ireland, Italy, Latvia, Lithuania, Luxembourg, Malta, Netherlands, Norway, Poland, Portugal, Pomania, Slovakia, Slovenia, Spain, Sweden, Switzerland, and U.K.

12. Safety Requirement

The power cable is for 13.2V DC only. Be sure the transceiver is off before connecting the leads of the power cable to the power supply. It is important to observe the polarity even if the unit is protected against the accidental inversion :

- * Red : Positive pole (+)
- * Black : Negative pole (-)

The same colors are present on the battery and in the fuse box of the car.

The unit must be wired for the negative ground only. To avoid damage, do not operate your CB radio without connecting a proper antenna.

13. Specification

GENERAL	Channel	40 (See the frequency band chart)
	Frequency Range	26.56 MHz ~ 28.00 MHz
	Operating mode	F3E (FM), A3E (AM)
	Frequency Control	PLL Synthesizer
	Frequency Tolerance	0.002%
	Operating Temperature Range	-10 to + 55 °C
	Microphone	Plug-in Type
	Input Voltage	13.2V DC ± 15%
	Size	124 (W) x 135 (L) x 37 (H)
	Weight	655 g
	Antenna Connector	Antenna Connector
TRANSMITTER	Power Output	Duty cycle 10% 4 Watts @ 13.2V DC
	Modulation	AM:from 85% to 95% FM:1.8KHz ± 0.2KHz
	Frequency Response	300Hz to 3000Hz
	Output Impedance	50ohms, Unbalanced
	Harmonic Suppression	More than -36dBm
	Current Drain	AM Full Mod. 1.6A Max.
RECEIVER	Receiving System	Dual conversion superheterodyne
	IF Frequencies	Double Conversion 1st 10.695MHz/2nd 455KHz
	Sensitivity	0.7µV for 10dB(S+N)/N in AM Mode 0.5µV for 20dB SINAD in FM Mode
	Audio Output Power	2.0W @ 8 Ohm
	Audio Distortion	Less then 8% @ 1KHz
	Image Rejection	60 dB
	Adjacent Channel Rejection	60 dB
	Conducted Spurious	More than 60 dB
	Frequency Response	300 to 2500Hz
	Built-in Speaker	8 Ohms, round
Squelch	Adjustable; Threshold less than 1 microvolt	

* Specification is subject to change without prior notice.

14. Restrictions on the use

COUNTRY	Settings	Use restrictions and other comments
BELGIUM SWITZERLAND	EU F EC	40 Ch - 4W FM - Individual licence is required 40 Ch - 1W AM - Individual licence is required
DENMARK,NORWAY LUXEMBOURG,CZECH	EC	40 Ch - 4W FM - Free use
FINLAND,PORTUGAL FRANCE,NETHERLANDS	EU F EC	40 Ch - 4W FM - Free use 40 Ch - 1W AM - Free use
GERMANY	D EU D2 EC	80 Ch - 4W FM - Individual licence is required 12 Ch - 1W AM - Individual licence is required 40 Ch - 1W AM - Use ch 4-15 only 40 Ch - 4W FM - Free use 12 Ch - 1W AM - Individual licence is required
	fx Allowed: from	26.960 to 27.410 MHz "BAPT 222 ZV 104"
GREECE	E EU F I EC	40 Ch - 4W FM - Free use 40 Ch - 4W AM - Free use
	T/R 20-02	
IRELAND	E EU F I EC	40 Ch - 4W FM - Free use 40 Ch - 1W AM - Free use
		S.I. No 436 of 1998. WIRELESS TELEGRAPHY ACT, 1926 (SECTIONS) (EXEMPTION OF CITIZENS' BAND (CB) RADIOS) ORDER, 1998
ITALY	E EU F I EC I2	40 Ch - 4W FM - General authorisation is required 40 Ch - 1W AM - General authorisation is required 34 Ch - 4W FM 34 Ch - 1W AM(ERP) *AM mode allowed on ch1-23 only
		PNF issued on DM 08.07.02 NOTES 49 A-B-C-D-E-G
SPAIN	E EU F EC	40 Ch - 4W FM - Individual licence is required 40 Ch - 4W AM - Individual licence is required
		Art. 57 - Law 11/1998 dated 24th April
SWEDEN	EU F EC	40 Ch - 4W FM - Free use 40 Ch - 1W AM - Individual licence is required
UK	UK EC	40 Ch - 4W FM - Individual licence is required
		UK-RA-MPT 1382/MPT1320; UK-R&TTE - S.I.L. 2000:730
POLAND	PL EU EC	40 Ch - 4W FM / AM - Free use

15. Frequency Table

	EU/E/F/	EC UK(CEPT)	I	I2	D		D2	PL	UK (ENG.)	
1	26.965	26.965	26.965	26.965	1	26.965	41 26.565	26.965	26.960	27.60125
2	26.975	26.975	26.975	26.975	2	26.975	42 26.575	26.975	26.970	27.61125
3	26.985	26.985	26.985	26.985	3	26.985	43 26.585	26.985	26.980	27.62125
4	27.005	27.005	27.005	27.005	4	27.005	44 26.595	27.005	27.000	27.63125
5	27.015	27.015	27.015	27.015	5	27.015	45 26.605	27.015	27.010	27.64125
6	27.025	27.025	27.025	27.025	6	27.025	46 26.615	27.025	27.020	27.65125
7	27.035	27.035	27.035	27.035	7	27.035	47 26.625	27.035	27.030	27.66125
8	27.055	27.055	27.055	27.055	8	27.055	48 26.635	27.055	27.050	27.67125
9	27.065	27.065	27.065	27.065	9	27.065	49 26.645	27.065	27.060	27.68125
10	27.075	27.075	27.075	27.075	10	27.075	50 26.655	27.075	27.070	27.69125
11	27.085	27.085	27.085	27.085	11	27.085	51 26.665	27.085	27.080	27.70125
12	27.105	27.105	27.105	27.105	12	27.105	52 26.675	27.105	27.100	27.71125
13	27.115	27.115	27.115	27.115	13	27.115	53 26.685	27.115	27.110	27.72125
14	27.125	27.125	27.125	27.125	14	27.125	54 26.695	27.125	27.120	27.73125
15	27.135	27.135	27.135	27.135	15	27.135	55 26.705	27.135	27.130	27.74125
16	27.155	27.155	27.155	27.155	16	27.155	56 26.715	27.155	27.150	27.75125
17	27.165	27.165	27.165	27.165	17	27.165	57 26.725	27.165	27.160	27.76125
18	27.175	27.175	27.175	27.175	18	27.175	58 26.735	27.175	27.170	27.77125
19	27.185	27.185	27.185	27.185	19	27.185	59 26.745	27.185	27.180	27.78125
20	27.205	27.205	27.205	27.205	20	27.205	60 26.755	27.205	27.200	27.79125
21	27.215	27.215	27.215	27.215	21	27.215	61 26.765	27.215	27.210	27.80125
22	27.225	27.225	27.225	27.225	22	27.225	62 26.775	27.225	27.220	27.81125
23	27.255	27.255	27.255	27.255	23	27.255	63 26.785	27.255	27.250	27.82125
24	27.235	27.235	27.235	27.245	24	27.235	64 26.795	27.235	27.230	27.83125
25	27.245	27.245	27.245	27.265	25	27.245	65 26.805	27.245	27.240	27.84125
26	27.265	27.265	27.265	26.875	26	27.265	66 26.815	27.265	27.260	27.85125
27	27.275	27.275	27.275	26.885	27	27.275	67 26.825	27.275	27.270	27.86125
28	27.285	27.285	27.285	26.895	28	27.285	68 26.835	27.285	27.280	27.87125
29	27.295	27.295	27.295	26.905	29	27.295	69 26.845	27.295	27.295	27.88125
30	27.305	27.305	27.305	26.915	30	27.305	70 26.855	27.305	27.300	27.89125
31	27.315	27.315	27.315	26.925	31	27.315	71 26.865	27.315	27.310	27.90125
32	27.325	27.325	27.325	26.935	32	27.325	72 26.875	27.325	27.320	27.91125
33	27.335	27.335	27.335	26.945	33	27.335	73 26.885	27.335	27.335	27.92125
34	27.345	27.345	27.345	26.955	34	27.345	74 26.895	27.345	27.340	27.93125
35	27.355	27.355	27.355		35	27.355	75 26.905	27.355	27.350	27.94125
36	27.365	27.365	27.365		36	27.365	76 26.915	27.365	27.360	27.95125
37	27.375	27.375	27.375		37	27.375	77 26.925	27.375	27.370	27.96125
38	27.385	27.385	27.385		38	27.385	78 26.935	27.385	27.380	27.97125
39	27.395	27.395	27.395		39	27.395	79 26.945	27.395	27.390	27.98125
40	27.405	27.405	27.405		40	27.405	80 26.955	27.405	27.400	27.99125

AM/FM FM

DECLARATION OF CONFORMITY

We, TTI Tech Co.,Ltd (TTI house, 1163-4, Gaepo-dong, Gangnam-gu, Seoul, Korea) declare on our sole responsibility that this equipment complies with the essential requirements of the Radio and Telecommunications Terminal Equipment Directive, 1999/5/EC, and that any applicable Essential Test Suite measurements have been performed.

Kind of equipment: MOBILE CB TRANSCEIVER

Type-designation: **TCB-550**

Version (where applicable):

This compliance is based on conformity with the following standards, specifications or documents:

EN 300 135-1	V1.1.2
EN 300 433-1	V1.1.3
EN 301 489-1	V1.6.1
EN 301 489-13	V1.2.1
EN 60950-1	

TCB-550 fulfills the limits defined in the paragraphs 6.5, 6.6, 6.8, and 6.9 of the 72/245/EEC.

CE 0700

N. Y. Kim
Director



Signature

TCB-550

TTI TECH CO., LTD. 

