



PNI A8020

Car multimedia player, Мултимедиен плейър за кола, Auto-Multimedia-Spieler, Reproductor multimedia de coche, Lecteur multimédia de voiture, Multimédia lejárászó auto, Multimedia player auto, Multimedia player auto

User manual - Ръководство за употреба - Bedienungsanleitung - Manual de usuario - Manuel utilisateur - Használati utasítás - Manuale utente - Manual de utilizare



EN	User manual	2
BG	Ръководство за употреба	6
DE	Bedienungsanleitung	10
ES	Manual de usuario	14
FR	Manuel utilisateur	18
HU	Használati utasítás	22
IT	Manuale utente	26
RO	Manual de utilizare	30

QUICK REFERENCE GUIDE

1. HOME SCREEN

The home screen includes: GPS navigation, Radio, Applications, Bluetooth, Music. Tap each icon of them to go to the corresponding application page. You can add different widgets, as the music player or file explorer. To add a widget, tap  and access WIDGETS tab.

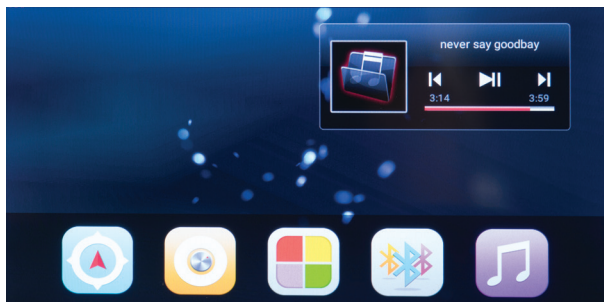

2. START AND SHUTDOWN

Plug in the car key and turn on the ignition to turn multimedia unit on. Turn off the ignition to shutdown.

Press and hold power icon  to power off. Tap it again to power on.

3. APPEARANCE CUSTOMIZATION

The system provides many wallpaper for selecting. Pressing the center empty space can enter the wallpaper settings.

4. SCROLL DOWN QUICK MENU

In the scroll down menu following functions are available: info about the WiFi network you are connected to, volume and brightness setup, screen shot, recent app etc.

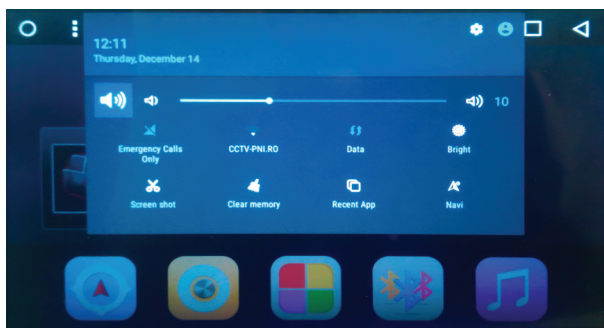

Note: as the system keeps updating, there might be some differences on some details.

5. GPS NAVIGATION



Tap on  to access GPS interface that offers you info about your location on the map (latitude and longitude), speed, altitude and direction.

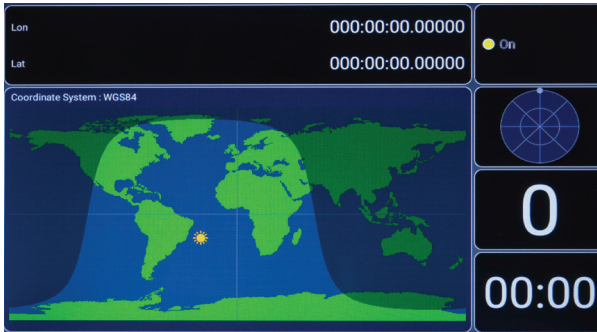

6. RADIO



Tap on  to access FM radio interface. You can save up to 18 radio channels.



7. APPLICATION



Tap on  to view all the applications installed in the system.

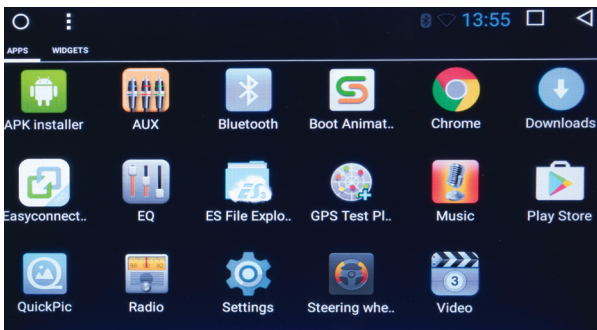

8. BLUETOOTH

Tap on  to access Bluetooth interface.

Bluetooth is a short-range wireless communication technology capable of exchanging information over a distance of about 5m without requiring a physical connection. It provides a convenient connection between your car navigation system and mobile phone.

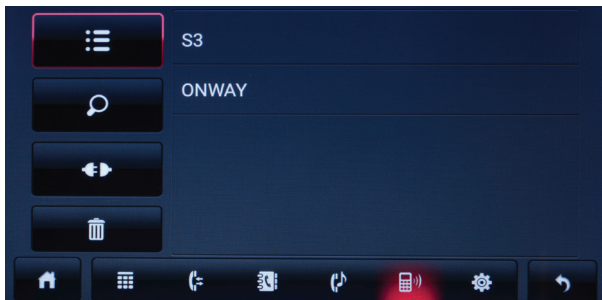

Connect your smart phone with the player PNI A8020.

After connecting both devices, you can receive and make calls, import your phonebook, or play music on your phone.

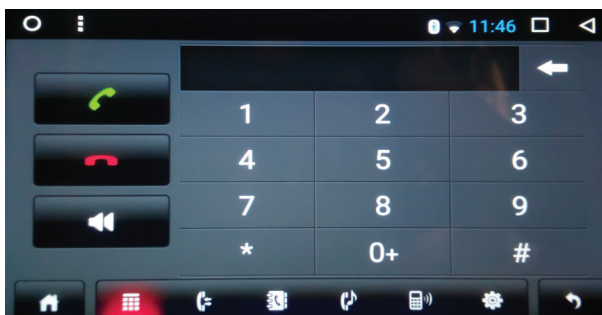

9. MUSIC

Tap on  to access the music player interface.

You can play music from the micro SD card, USB memory, or the player's internal memory.



TECHNICAL SPECIFICATIONS:

Platform	Allwinner T3L
OS	Android 6.0.1
CPU	Quad Core 1.0G
RAM	DDR3 1.0GB
ROM	8GB
SD	micro SD max. 32GB (not included)
Screen	HD 1024 x 600px
Wifi	Yes
Bluetooth	A2DP

Power voltage	12V / 10A
Maximum output power	45W x 4
AV output	Audio: 4.1 Video: 2
AV input	Audio: 2 channels Video: 2 (one for camera, one for AUX in)

Disc support	SVCD/DVCD/DVD/VCD/CD/CD-R/CD-RW/ JPEG/WMA/MP3/MP4/DIVX/MP5/AVI/MPG/ TS 1080P H.264 format etc.
FM Frequency range	87.5~108 MHz

CONNECTION DIAGRAM:

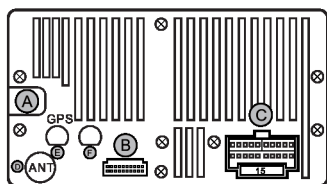

Socket Map

A: USB & Camera
B: RCA Media
C: Power Cable

D: Radio Antenna
E: GPS Antenna
F: D-TV Antenna



Power Connector

01: RX
02: SWC1
03: ACC
04: Front L-
05: Front L+
06: Brake
07: Rear R-
08: Rear R+
09: Front R+
10: Front R-
11: TX
12: SWC2
13: ILL+
14: Reverse
15: GND
16: BATT+
17: FM ANT
18: AMP
19: Rear L-
20: Rear L+

RCA Connector

01: GND
02: Rear L out
03: Video out 1
04: Front L out
05: AUX-in R
06: Subwoofer
07: GND
08: N/A
09: N/A
10: N/A
11: Video out 2
12: AUX-in V
13: GND
14: Front R out
15: GND
16: AUX-in L
17: Rear R out
18: N/A
19: N/A
20: N/A

БЪРЗИ СПРАВКИ

1. НАЧАЛНИЯ ЕКРАН

Началният екран включва: GPS навигация, Радио, Приложения, Bluetooth, Музика. Докоснете всяка икона от тях, за да отидете на съответната страница на приложението. Можете да добавяте различни приспособления като музикален плейър или файловия браузър.

За да добавите приспособление, натиснете  и достъп до раздела WIDGETS.

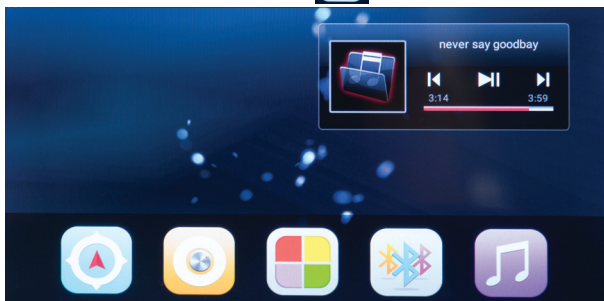

2. НАЧАЛО И ИЗКЛЮЧВАЙТЕ

Включете ключа на колата и включете запалването, за да включите мултимедийното устройство. Изключете запалването за изключване.

Натиснете и задръжте иконата за захранване  за изключване. Докоснете го отново, за да включите.

3. ПОДОБРЯВАНЕ НА ПЪТЯ

Системата осигурява много тапети за избор. Натискането на празно място в центъра може да въведе настройките за тапет.

4. БЪРЗО МЕНЮ НА СВЪРЗВАНЕ НА НАДОЛУ

В менюто за превъртане надолу са достъпни следните функции: информация за WiFi мрежата, към която сте свързани, настройка на силата на звука и яркостта, снимка на екрана, последно приложение и т.н.

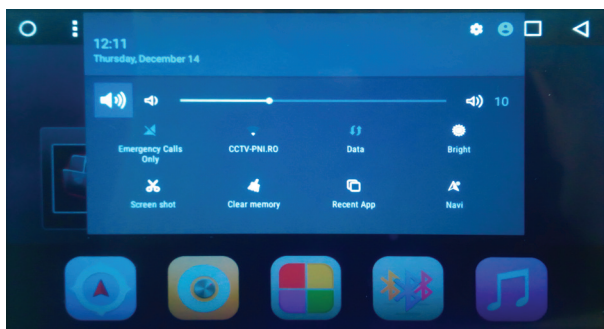

Забележка: тъй като системата продължава да се актуализира, може да има някои различия по някои детайли.

5. GPS НАВИГАЦИЯ

Натисни  за достъп до GPS интерфейс, който ви предоставя информация за местоположението ви на картата (географска ширина и дължина), скорост, височина и посока.

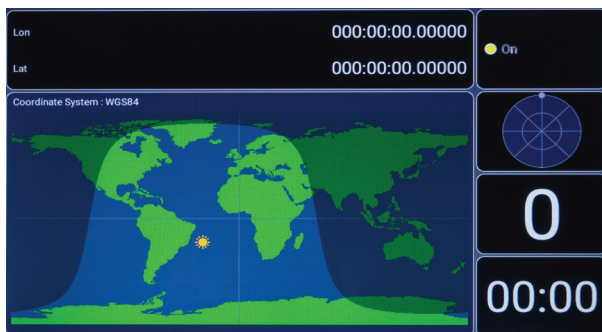

6. РАДИО

Натисни  за достъп до FM радио интерфейс. Можете да запаметите до 18 радиоканали.



7. ПРИЛОЖЕНИЕ

Натисни  за да видите всички приложения, инсталирани в системата.

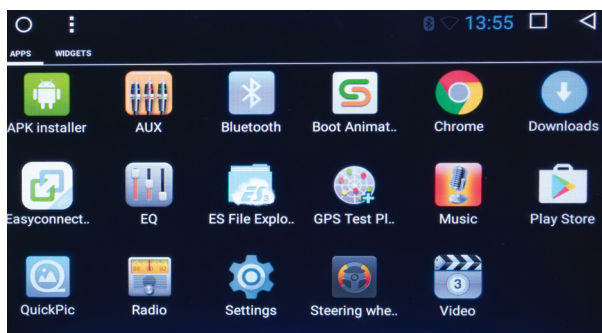

8. BLUETOOTH

Натисни  за достъп до Bluetooth интерфейса.

Bluetooth е технология за безжична комуникация с малък обхват, способна да обменя информация на разстояние от около 5 метра, без да изисква физическа връзка. Той осигурява удобна връзка между навигационната система за автомобил и мобилния телефон.



Свържете вашия смартфон с плейъра PNI A8020.

След като свържете и двете устройства, можете да приемате и осъществявате повиквания, да импортирате телефонния си указател или да слушате музика от телефона си.

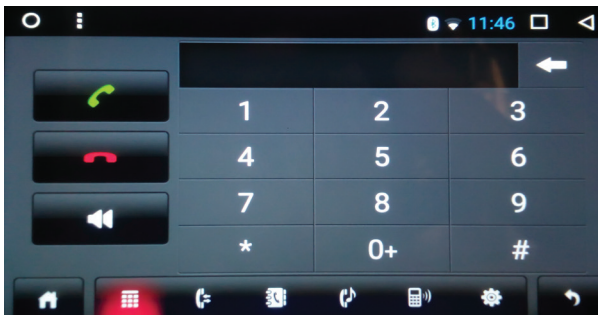

9. MUSIC

Натисни  за достъп до интерфейса на музикалния плейър.

Можете да възпроизведете музика от микро SD картата, USB паметта или вътрешната памет на плейъра.



ТЕХНИЧЕСКИ СПЕЦИФИКАЦИИ:

платформа	Allwinner T3L
OS	Android 6.0.1
CPU	Quad Core 1.0G
RAM	DDR3 1.0GB
ROM	8GB
SD	micro SD макс. 32 GB (не са включени)
екран	HD 1024 x 600px
Wifi	Да
Bluetooth	A2DP

Захранващо напрежение	12V / 10A
Максимална изходна мощност	45W x 4
AV изход	звук: 4.1
	Видео: 2
AV вход	звук: 2 канали
	Видео: 2 (един за камера, един за AUX в)

Поддръжка на дискове	SVCD/DVCD/DVD/VCD/CD/CD-R/CD-RW/ JPEG/WMA/MP3/MP4/DIVX/MP5/AVI/ MPG/TS 1080P H.264 формат etc.
FM Честотен диапазон	87.5~108 MHz

СХЕМА НА ДИАГРАМАТА:

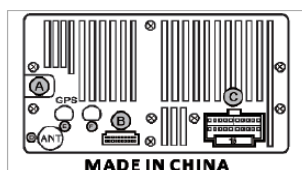

Връзки

A: USB & видеокamera	D: Радио антена
B: съединител RCA	E: GPS антена
C: Захранващ кабел	F: N/A

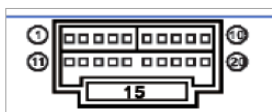

главен конектор

01: RX	11: TX
02: SWC1	12: SWC2
03: ACC контакт	13: светлина +
04: Ляво момиче -	14: обратен +
05: отляво +	15: GND текущата маса
06: Франция	16: батерия +
07: точно обратно -	17: FM ANT
08: точно обратно +	18: AMF
09: отясно -	19: Отляво назад -
10: отясно +	20: Отляво назад +

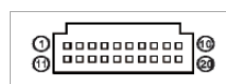

RCA връзки

01: GND	11: видео изход 2
02: Заден изход	12: AUX видео вход
03: Видео изход 1	13: GND текущата таблица
04: Излез от момичето	14: десен преден изход
05: AUX правилно влизане	15: GND текущата таблица
06: суббуфер	16: AUX ляво влизане
07: GND	17: десен заден изход
08: N/A	18: N/A
09: N/A	19: N/A
10: N/A	20: N/A

SCHNELLES HANDBUCH

1. STARTBILDSCHIRM

Die Hauptschnittstelle umfasst: GPS Navigation, Radio, Anwendungen, Bluetooth, Musik. Berühren Sie jedes Piktogramm, um die entsprechende Seite der Anwendung abzurufen.

Sie können verschiedene Widgets hinzufügen, wie den Musik- Player oder die Explorer- Dateien.

Um ein Widget hinzuzufügen, drücken Sie auf das Piktogramm  und rufen Sie das Tab

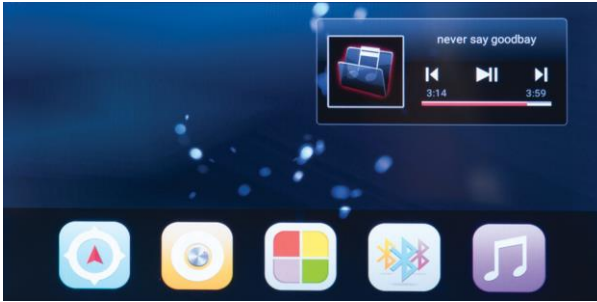

WIDGETS ab.

2. EIN- UND AUSSCHALTEN DER VORRICHTUNG

Stecken Sie den Schlüssel in den Bord und schalten Sie die Zündung ein, um den Player zu starten.

Halten Sie das Piktogramm  gedrückt, damit der Player startet. Halten Sie es wieder gedrückt, um den Player auszuschalten.

3. PERSONALISIERUNG DES HINTERGRUNDBILDES

Sie können das Hintergrundbild ändern: halten Sie lange auf den Bildschirm über den Piktogrammen gedrückt. Aus dem Fenster, das sich öffnet, wählen Sie Wallpapers. Wählen Sie das gewünschte Hintergrundbild.

4. SCHNELLES MENÜ

Im schnellen Menü sind die folgenden Optionen verfügbar: Informationen über das WiFi Netz, woran Sie angeschlossen sind, Volumen- und Lichteinstellung, Bildschirmabzug, neuliche Anwendungen, usw.



Bemerkung: wegen der Systemaktualisierung, können Unterschiede beim Anzeigen der Informationen auftreten, die im schnellen Menü verfügbar sind.

5. GPS NAVIGATION

Drücken Sie auf das Piktogramm  um die Schnittstelle der GPS Anwendung abzurufen. Die GPS Anwendung bietet Ihnen Informationen über Ihre Stellung auf der Karte (Breite, Länge), die Geschwindigkeit, womit Sie fahren, die Höhe und die Richtung.

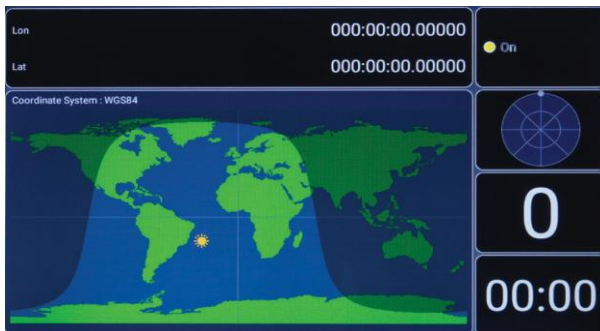

6. RADIO

Drücken Sie auf das Piktogramm  um die Radio- Schnittstelle abzurufen. Sie können bis zu 18 FM Rundfunksender speichern.



7. ANWENDUNGEN

Drücken Sie auf das Piktogramm  um die Schnittstellen mit allen Anwendungen, die im System installiert sind, aufzumachen.

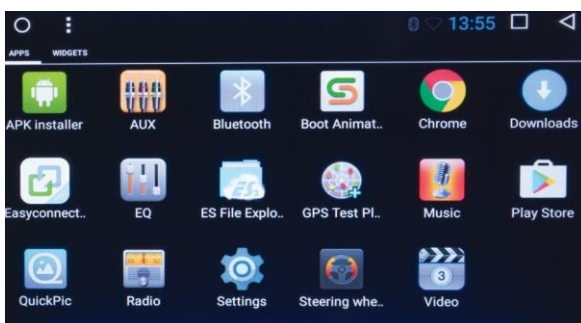

8. BLUETOOTH

Drücken Sie auf das Piktogramm  um die Bluetooth- Schnittstelle abzurufen. Bluetooth ist eine Wireless Kommunikationstechnologie auf kurzen Strecken (ungefähr von 5 m) wodurch die Informationen ohne eine physische Verbindung ausgetauscht werden können.

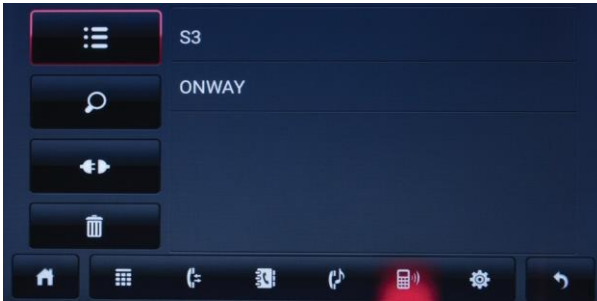

Schliessen Sie durch Bluetooth das Handy und den PNI A8020 Player an. Nach dem Anschluss der zwei Vorrichtungen können Sie Anrufe annehmen und anrufen, die Agenda- Einträge importieren oder die Musik aus dem Handy aufnehmen.

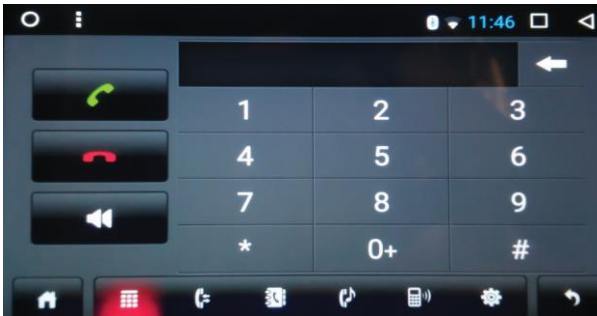

9. MUSIK

Drücken Sie auf das Piktogramm  um die Schnittstelle des Musikplayers abzurufen. Sie können die Musik von der SD Mikrokarte, vom USB Speicher oder vom internen Speicher des Players herunterladen.



TECHNISCHE SPEZIFIKATIONEN:

Plattform	Allwinner T3L
OS	Android 6.0.1
CPU	Quad Core 1.0G
RAM	DDR3 1.0GB
ROM	8GB
SD	micro SD maxim 32GB (nicht eingeschlossen)
Bildschirm	HD 1024 x 600px
Wifi	Ja
Bluetooth	A2DP

Versorgungsspannung	12V / 10A
Leistungsgrenze	45W x 4
AV Ausgang	Audio: 4.1 Video: 2
AV Eingang	Audio: 2 Sender Video: 2 (1 für Kamera, 1 für AUX in)

Verträgt	SVCD/DVCD/DVD/VCD/CD/CD-R/CD-RW/ JPEG/WMA/MP3/MP4/DIVX/MP5/AVI/MPG/ TS 1080P H.264 format etc.
FM Frequenzband	87.5~108 MHz

DAS ANSCHLUSSDIAGRAMM:

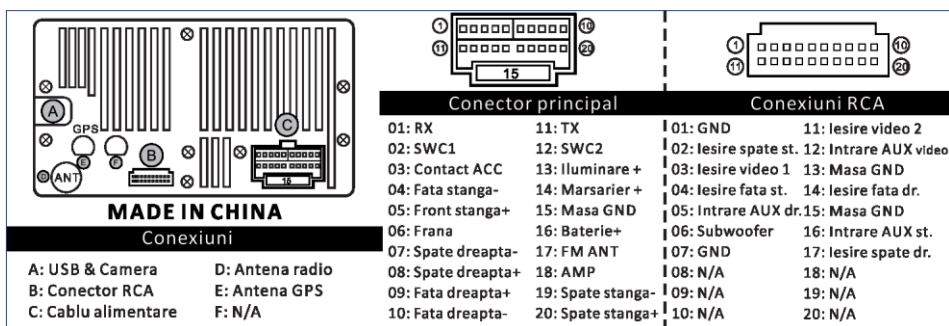

GUÍA RÁPIDA DE USO

1. PANTALLA DE INICIO

La interfaz principal incluye: navegación GPS, radio, aplicaciones, Bluetooth, música. Toca cada icono para acceder a la página de la aplicación correspondiente.

Puede agregar diferentes widgets, como el reproductor de música o los archivos de Explorer. Para agregar un widget, toque el icono  y vaya al tab WIDGETS.

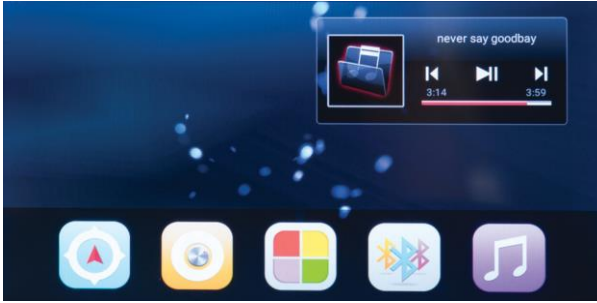

2. ENCENDER Y APAGAR EL DISPOSITIVO

Inserte la llave en el tablero y ponga el interruptor de encendido para iniciar el reproductor.

Mantenga tocado el icono  para encender el reproductor. Mantenga de nuevo tocado para apagar el reproductor.

3. PERSONALIZAR LA IMAGEN DEL FONDO

Puede cambiar la imagen de fondo: mantenga tocado la pantalla durante mucho tiempo en el área sobre los iconos. Desde el icono que se abre, seleccione Wallpapers. Elija el fondo de pantalla deseado.

4. MENÚ RÁPIDO

En el menú rápido puede encontrar: información sobre la red WiFi a la que está conectado, configuración de volumen y brillo, captura de pantalla, aplicaciones recientes, etc.



Nota: Debido a la actualización del sistema, pueden haber diferencias en la visualización de la información disponible en el menú rápido.

5. NAVEGACIÓN GPS

Toque el icono  para acceder la interfaz de la aplicación GPS.

La aplicación GPS le ofrece información sobre su posición en la mapa (latitud, longitud), la velocidad de mover, la altitud y la dirección.

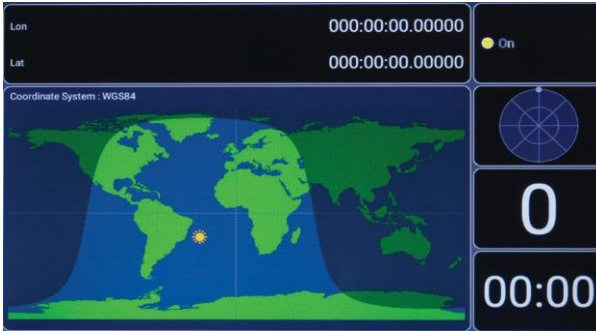

6. RADIO

Toque el icono  para acceder a la interfaz radio.

Puede salvar hasta 18 emisoras de radio FM.



7. APLICACIONES

Toque el icono  para abrir la interfaz con todas las aplicaciones instaladas en el sistema.

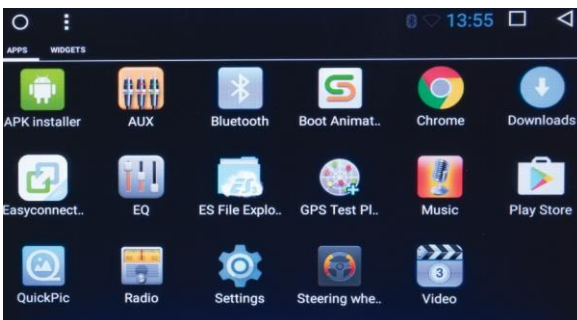

8. BLUETOOTH

Toque el icono  para acceder a la interfaz Bluetooth.

Bluetooth es una tecnología de comunicación inalámbrica en distancias cortas (aproximadamente 5 m) que puede intercambiar información sin una conexión física.

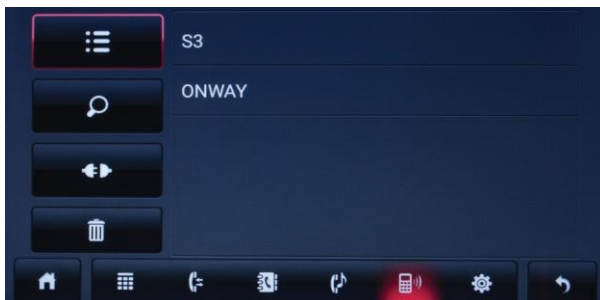

Conecte el teléfono móvil y el reproductor A8020 PNI a través de Bluetooth.

Después de conectar ambos dispositivos, puede recuperar y hacer llamadas, importar su agenda o reproducir música en su teléfono.

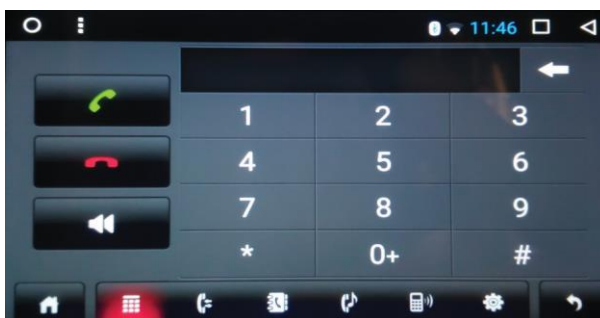

9. MÚSICA

Toque el icono  para acceder la interfaz del reproductor de música.

Puede reproducir música desde la tarjeta micro SD, la memoria USB o la memoria interna del reproductor.



ESPECIFICACIONES TÉCNICAS:

Plataforma	Allwinner T3L
OS	Android 6.0.1
CPU	Quad Core 1.0G
RAM	DDR3 1.0GB
ROM	8GB
SD	micro SD máximo 32GB (no está incluido)
Pantalla	HD 1024 x 600px
Wifi	Sí
Bluetooth	A2DP

Tensión de alimentación	12V / 10A
Potencia máxima	45W x 4
Salida AV	Audio: 4.1
	Video: 2
Entrada AV	Audio: 2 canales
	Video: 2 (1 para cámara, 1 para AUX in)

Soporta	SVCD/DVCD/DVD/VCD/CD/CD-R/CD-RW/ JPEG/WMA/MP3/MP4/DIVX/MP5/AVI/MPG/ TS 1080P H.264 format etc.
Frecuencia FM	87.5~108 MHz

DIAGRAMA CONEXIONES:

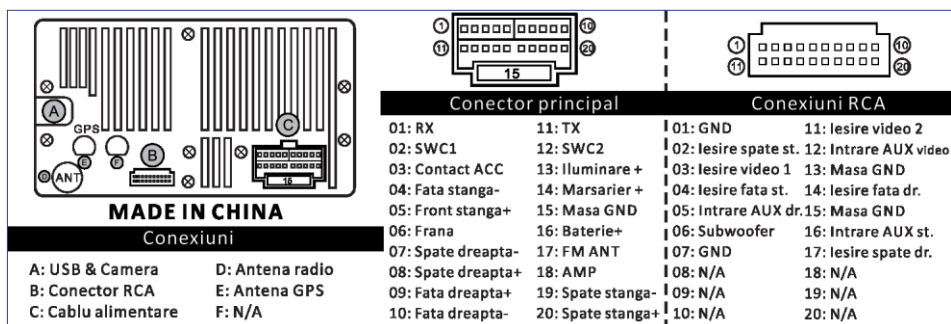

GUIDE DE RÉFÉRENCE RAPIDE

1. ÉCRAN D'ACCUEIL

L'écran d'accueil comprend: navigation GPS, radio, applications, Bluetooth, musique. Appuyez sur chaque icône pour accéder à la page de l'application correspondante. Vous pouvez ajouter différents widgets, comme la musique ou l'explorateur de fichiers.

Pour ajouter un widget, appuyez sur  et accédez à l'onglet WIDGETS.



2. OUVRIR ET FERMER

Branchez la clé de la voiture et allumez le contact pour allumer l'unité multimédia. Tournez le contact pour fermer.

Appuyez sur l'icône d'alimentation et maintenez-la enfoncée  pour éteindre. Appuyez à nouveau pour l'allumer.

3. APPARENCE PERSONNALISATION

Le système fournit de nombreux fonds d'écran pour la sélection. En appuyant sur l'espace vide central peut entrer les paramètres de papier peint.

4. FAITES DEFILER LE MENU RAPIDE

Dans le menu déroulant, les fonctions suivantes sont disponibles: informations sur le réseau WiFi auquel vous êtes connecté, configuration du volume et de la luminosité, capture d'écran, application récente etc.

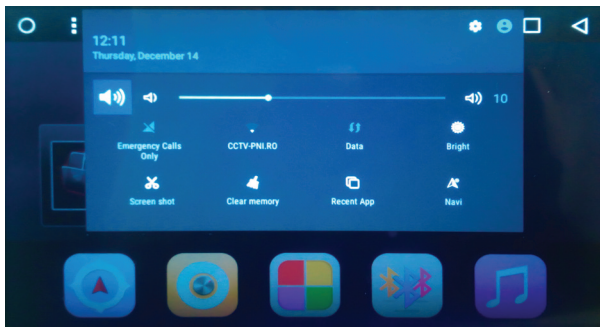

Remarque: au fur et à mesure que le système se met à jour, il peut y avoir des différences dans certains détails.

5. GPS NAVIGATION

Appuyez sur  pour accéder à l'interface GPS qui vous donne des informations sur votre position sur la carte (latitude et longitude), la vitesse, l'altitude et la direction.

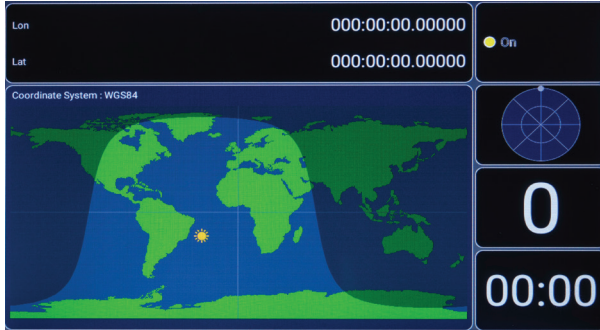

6. RADIO

Appuyez sur  accéder à l'interface radio FM. Vous pouvez enregistrer jusqu'à 18 canaux de radio.



7. L'APPLICATION

Appuyez sur  pour afficher toutes les applications installées sur le système.

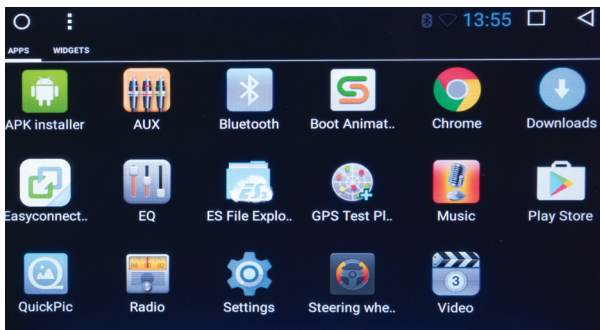

8. BLUETOOTH

Appuyez sur  pour accéder à l'interface Bluetooth.

Bluetooth est une technologie de communication sans fil à courte portée capable d'échanger des informations sur une distance d'environ 5 m sans nécessiter de connexion physique. Il fournit une connexion pratique entre votre système de navigation automobile et votre téléphone portable.

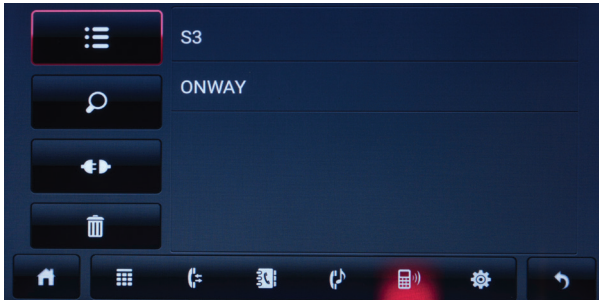

Connectez votre smartphone avec le lecteur PNI A8020.

Après avoir connecté les deux appareils, vous pouvez recevoir et passer des appels, importer votre répertoire ou écouter de la musique sur votre téléphone.

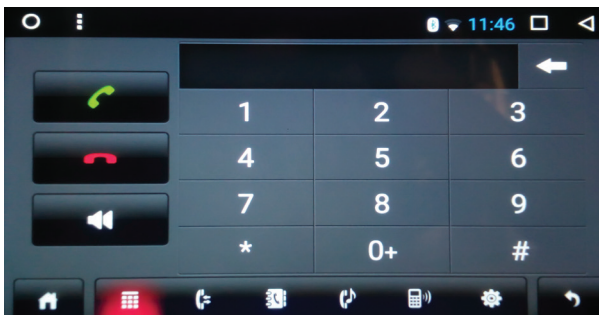

9. LA MUSIQUE

Appuyez sur  pour accéder à l'interface du lecteur de musique.

Vous pouvez écouter de la musique à partir de la carte micro SD, de la clé USB ou de la mémoire interne du lecteur.



SPÉCIFICATIONS TECHNIQUES:

Platform	Allwinner T3L
OS	Android 6.0.1
CPU	Quad Core 1.0G
RAM	DDR3 1.0GB
ROM	8GB
SD	micro SD max. 32GB (non inclus)
Écran	HD 1024 x 600px
Wifi	Oui
Bluetooth	A2DP

Tension d'alimentation	12V / 10A
Puissance de sortie maximale	45W x 4
AV sortie	L`audio: 4.1
	Vidéo: 2
AV entrée	L`audio: 2 canaux
	Vidéo: 2 (un pour la caméra, un pour AUX in)

Support de disque	SVCD/DVCD/DVD/VCD/CD/CD-R/CD-RW/ JPEG/WMA/MP3/MP4/DIVX/MP5/AVI/MPG/ TS 1080P H.264 format etc.
FM Gamme de fréquences	87.5~108 MHz

DIAGRAMME DE CONNEXION:

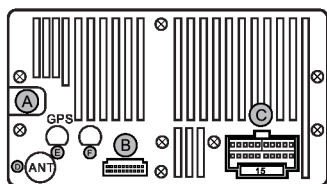

Socket Map

A: USB & Camera
B: RCA Media
C: Power Cable

D: Radio Antenna
E: GPS Antenna
F: D-TV Antenna



Power Connector

01: RX	11: TX
02: SWC1	12: SWC2
03: ACC	13: ILL+
04: Front L-	14: Reverse
05: Front L+	15: GND
06: Brake	16: BATT+
07: Rear R-	17: FM ANT
08: Rear R+	18: AMP
09: Front R+	19: Rear L-
10: Front R-	20: Rear L+

RCA Connector

01: GND	11: Video out 2
02: Rear L out	12: AUX-in V
03: Video out 1	13: GND
04: Front L out	14: Front R out
05: AUX-in R	15: GND
06: Subwoofer	16: AUX-in L
07: GND	17: Rear R out
08: N/A	18: N/A
09: N/A	19: N/A
10: N/A	20: N/A

GYORS HASZNÁLATI ÚTMUTATÓ

1. KEZDŐKÉPERNYŐ

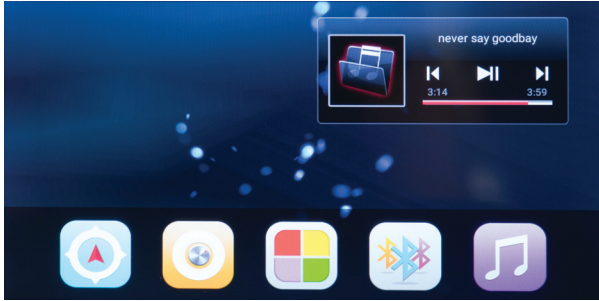

A fő felület tartalmazza: GPS navigációs rendszer, Radió, Alkalmazások, Bluetooth, Zene. Nyomja meg mindegyik ikon, a megfelelő alkalmazás oldal eléréséhez.

Különböző widget-eket hozzá lehet adni, mint például zenelejátszó vagy Explorer fájl. Hogy hozzáadjon egy widget-et, nyomja meg  ikont és lépjen be a WIDGETS tab-ba.



2. KÉSZÜLÉK ELINDÍTÁSA ÉS LEÁLLÍTÁSA

Helyezze a kulcsot a fedélzetre, és tegye a gyújtáskapcsolót a lejátszó indításához.

Tartsa lenyomva  ikont, hogy elindítsa a lejátszót. Tartsa újból lenyomva , hogy leállítsa a lejátszót.

3. HÁTTÉRKÉPEK SZEMÉLYRE SZABÁSA

Megváltoztathatja a háttérképet: tartsa lenyomva a képernyőn az ikonok fölötti területet.

Az ablak miután megnyitódik válassza ki a Wallpapers-t. Válassza ki a kívánt háttérképet.

4. GYORS MENÜ

A gyors menüben a következők elérhetőek: információk a WiFi hálózatról ahol csatlakoztatva van, hangerőszabályozó és fényérzékenység, képrögzítés, jelenlegi alkalmazások stb.

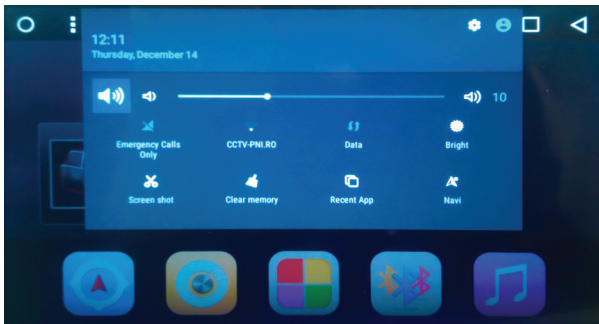

Megjegyzés : rendszer frissítésnek köszönhetően,előfordulhatnak különbségek a gyorsmenüben elérhető információk megjelenítésében.

5. GPS NAVIGÁCIÓS RENDSZER



Nyomja meg  ikont, hogy hozzáférjen a GPS alkalmazás felületéhez. A GPS alkalmazás tájékoztatást nyújt a térképen történő elhelyezkedéséről és az irányról.

elhelyezkedéséről és az irányról.

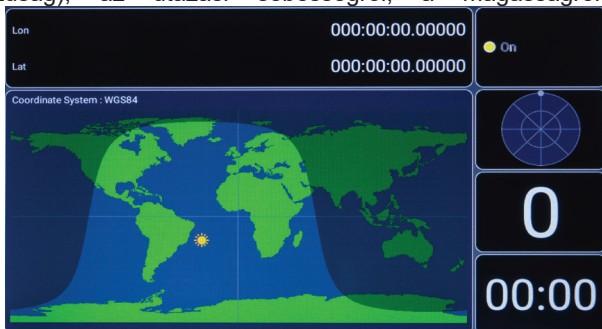

6. RÁDIÓ



Nyomja meg  ikont, hogy a rádió felületéhez érjen. 18 FM csatornát menthet le.



7. APLKALMAZÁSOK



Nyomja meg  ikont, hogy megnyissa a felületet az összes telepített alkalmazással amely a rendszerben található.

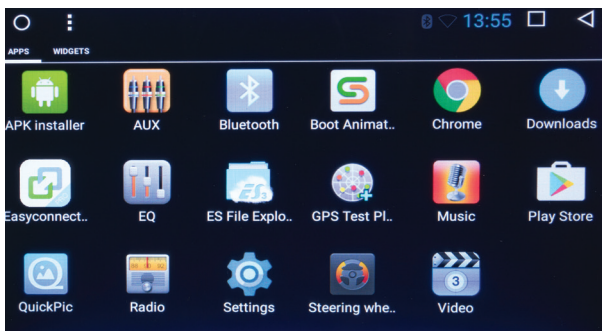

8. BLUETOOTH

Nyomja meg  ikont , hogy ehhez a felülethez hozzáférjen.

A Bluetooth egy rövid távú (kb. 5 m) távolságú vezeték nélküli kommunikációs technológia, amely fizikai kapcsolat nélkül képes információcserére.

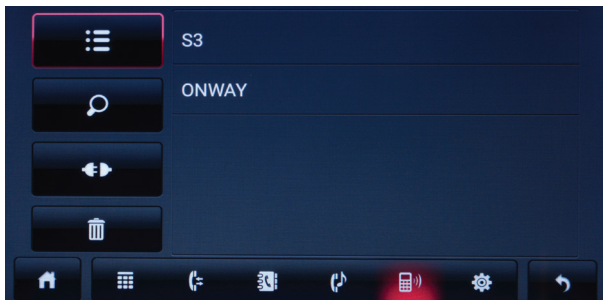

Csatlakoztassa a mobiltelefont és az A8020 PNI lejátszót Bluetooth-on keresztül.

A két eszköz csatlakoztatása után lekérhet és hívhat, importálhat telefonkönyvét vagy zenét játszhat le a telefonon.

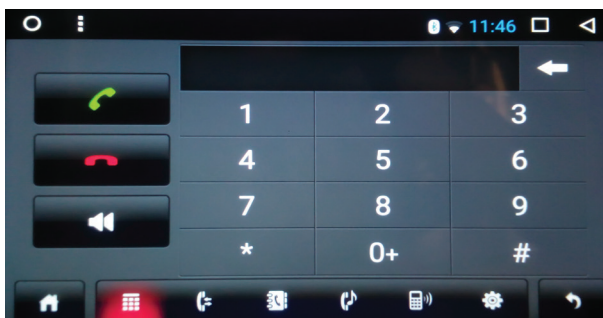

9. ZENE

Nyomja meg  ikont , hogy hozzáférjen a zenelejátszó felületéhez.

Lejátszhatja a zenét a mikro SD-kártyáról, az USB-memóriából vagy a lejátszó belső memóriájából.



MŰSZAKI ADATOK:

Emelvény	Allwinner T3L
OS	Android 6.0.1
CPU	Quad Core 1.0G
RAM	DDR3 1.0GB
ROM	8GB
SD	micro SD max. 32GB (nem tartalmazza)
Képernyő	HD 1024 x 600px
wifi	Igen
Bluetooth	A2DP

Tápfeszültség	12V / 10A
Maximális kimeneti teljesítmény	45W x 4
AV kimenet	Audio: 4.1
	Video: 2
AV bemenet	Audio: 2 csatornák
	Video: 2 (egy a kamera, az egyik az AUX bemenethez)

Lemez támogatás	SVCD/DVCD/DVD/VCD/CD/CD-R/CD-RW/ JPEG/WMA/MP3/MP4/DIVX/MP5/AVI/MPG/ TS 1080P H.264 format etc.
FM Frekvencia tartomány	87.5~108 MHz

CSATLAKOZÁSI DIAGRAM:

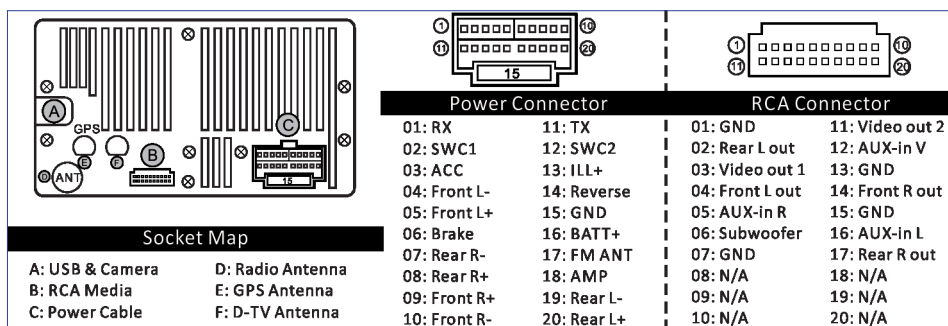

GUIDA RAPIDA

1. LO SCHERMO DI START

L'interfaccia principale include: Navigazione GPS, Radio, Applicazioni, Bluetooth, Musica. Toccare ciascuna icona per accedere alla pagina dell'applicazione corrispondente.

Può aggiungere diversi widget, come lettori di musica o Explorer di file. Per aggiungere un widget,

toccare l'icona  e accedere il tab WIDGETS.

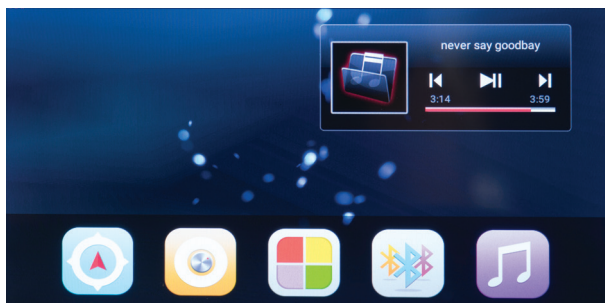

2. AVVIAMENTO ED ARRESTO DEL DISPOSITIVO

Inserire la chiave nel contatto per avviare il lettore.

Mantenere premuta l'icona  per accendere il player. Tenere premuto nuovamente per spegnere il player.

3. PERSONALIZZAZIONE IMMAGINE DI SFONDO

Può cambiare l'immagine di sfondo: tenere premuto a lungo lo schermo nell'area sopra le icone. Dalla finestra che si apre, selezionare Wallpapers. Scegliere lo sfondo desiderato.

4. MENU RAPIDO

Nel menu rapido sono disponibili: informazioni sulla rete WiFi a cui sia connesso, impostazione del volume e della luminosità, cattura dello schermo, applicazioni recenti, ecc.

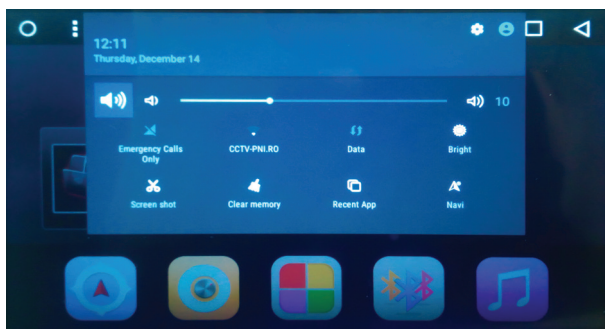

Nota: a causa dell'aggiornamento del sistema, potrebbero esserci delle differenze nella visualizzazione delle informazioni disponibili nel menu rapido.

5. NAVIGAZIONE GPS



Premere l'icona  per accedere l'interfaccia dell'applicazione GPS.

L'applicazione GPS fornisce informazioni sul posizionamento sulla mappa (latitudine, longitudine), la velocità alla quale viaggerete, l'altitudine e la direzione.

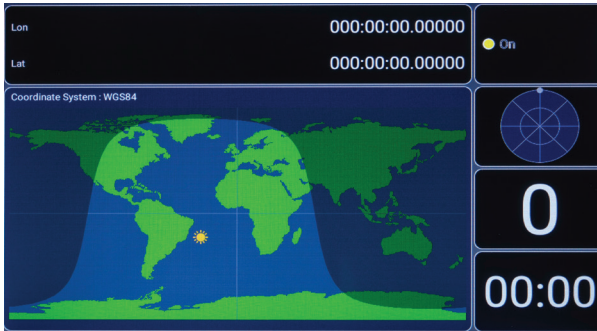

6. RADIO



Premere l'icona  per accedere l'interfaccia radio.

È possibile salvare fino a 18 stazioni radio FM.



7. APPLICAZIONI



Premere l'icona  per aprire l'interfaccia con tutte le applicazioni installate nel sistema.

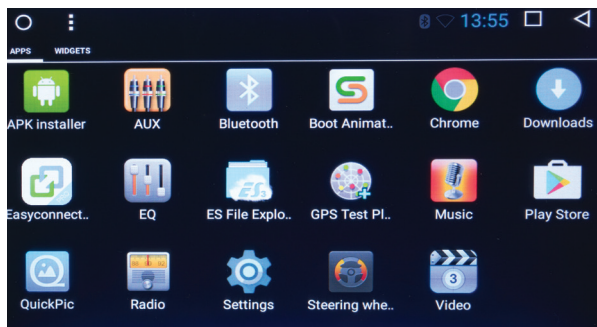

8. BLUETOOTH



Premere l'icona  per accedere l'interfaccia Bluetooth.

Il Bluetooth è una tecnologia di comunicazione wireless a breve distanza (circa 5 m) che può scambiare informazioni senza una connessione fisica.

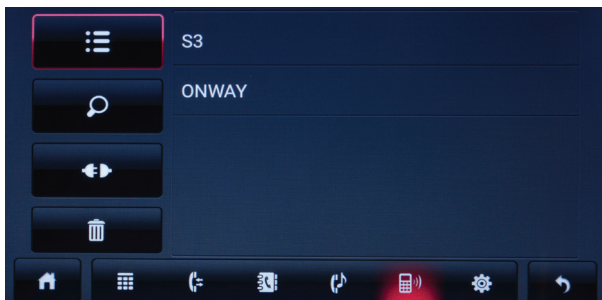

Connettere il telefono cellulare e il lettore PNI A8020 tramite Bluetooth.

Dopo aver connesso entrambi i dispositivi, è possibile ricevere e effettuare chiamate, importare la rubrica o riprodurre musica sul telefono.

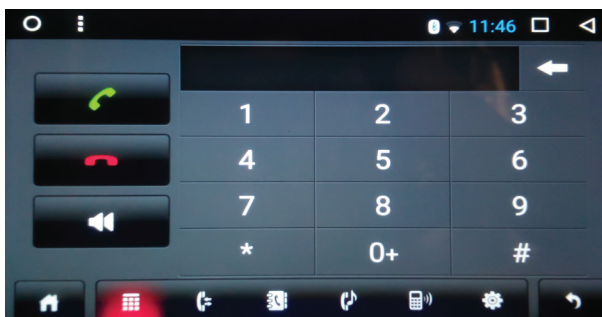

9. MUSICA



Premere l'icona  per accedere l'interfaccia di riproduzione musica.

È possibile riprodurre musica dalla scheda micro SD, dalla memoria USB o dalla memoria interna del lettore.



SPECIFICHE TECNICHE:

Piattaforma	Allwinner T3L
OS	Android 6.0.1
CPU	Quad Core 1.0G
RAM	DDR3 1.0GB
ROM	8GB
SD	micro SD al massimo 32GB (non è incluso)
Schermo	HD 1024 x 600px
Wifi	Da
Bluetooth	A2DP

Tensione di alimentazione	12V / 10A
Potenza massima	45W x 4
Uscita AV	Audio: 4.1
	Video: 2
Ingresso AV	Audio: 2 canali
	Video: 2 (1 per la camera, 1 per AUX in)

Supporta	SVCD/DVCD/DVD/VCD/CD/CD-R/CD-RW/ JPEG/WMA/MP3/MP4/DIVX/MP5/AVI/MPG/ TS 1080P H.264 formato etc.
Frequenza FM	87.5~108 MHz

DIAGRAMMA CONNESSIONI:

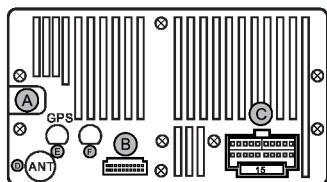

Socket Map

- | | |
|-----------------|------------------|
| A: USB & Camera | D: Radio Antenna |
| B: RCA Media | E: GPS Antenna |
| C: Power Cable | F: D-TV Antenna |



Power Connector

RCA Connector

01: RX	11: TX	01: GND	11: Video out 2
02: SWC1	12: SWC2	02: Rear L out	12: AUX-in V
03: ACC	13: ILL+	03: Video out 1	13: GND
04: Front L-	14: Reverse	04: Front L out	14: Front R out
05: Front L+	15: GND	05: AUX-in R	15: GND
06: Brake	16: BATT+	06: Subwoofer	16: AUX-in L
07: Rear R-	17: FM ANT	07: GND	17: Rear R out
08: Rear R+	18: AMP	08: N/A	18: N/A
09: Front R+	19: Rear L-	09: N/A	19: N/A
10: Front R-	20: Rear L+	10: N/A	20: N/A

GHID RAPID DE UTILIZARE

1. ECRANUL DE START

Interfata principala include: Navigatie GPS, Radio, Aplicatii, Bluetooth, Muzica. Atingeti fiecare pictograma pentru a accesa pagina corespunzatoare a aplicatiei.

Puteti adauga diferite widget-uri, cum ar fi player-ul muzical sau Explorer fisiere. Pentru a adauga un widget, apasati pictograma  si accesati tab-ul WIDGETS.

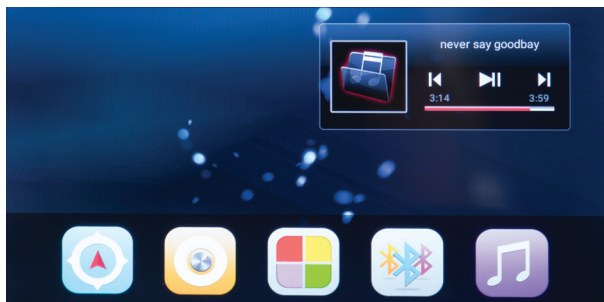

2. PORNIREA SI OPRIREA DISPOZITIVULUI

Introduceti cheia in bord si puneti contactul pentru a porni player-ul.

Tineti apasata pictograma  pentru a porni player-ul. Tineti din nou apasat pentru a opri player-ul.

3. PERSONALIZARE IMAGINE DE FUNDAL

Puteti schimba imaginea de fundal: tineti apasat lung pe ecran in zona deasupra pictogramelor. Din fereastra care se deschide selectati Wallpapers. Alegeti imaginea de fundal dorita.

4. MENIU RAPID

In meniul rapid sunt disponibile: informatii despre reseaua WiFi la care sunteti conectat, setare volum si luminozitate, captura de ecran, aplicatii recente etc.

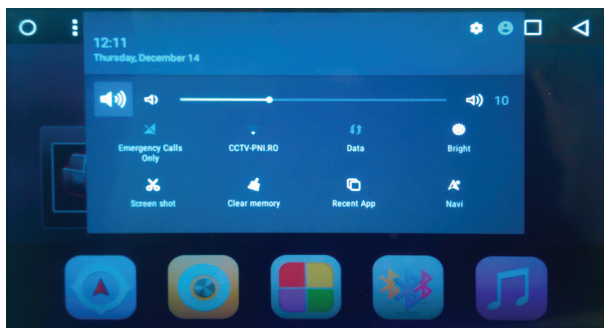

Nota: datorita actualizarii sistemului, ar putea aparea diferente in afisarea informatiilor disponibile in meniul rapid.

5. NAVIGATIE GPS



Apasati pictograma pentru a accesa interfata aplicatiei GPS.

Aplicatia GPS va ofera informatii despre pozitionarea Dvs. pe harta (latitudine, longitudine), viteza cu care va deplasati, altitudine si directia.

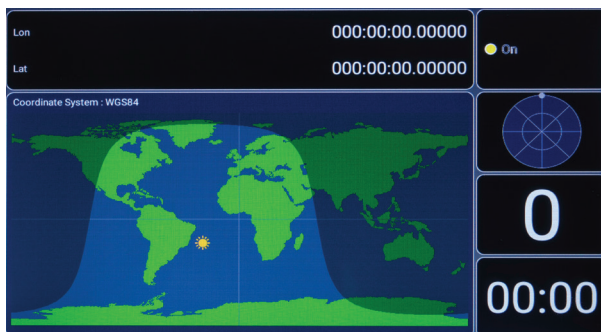

6. RADIO



Apasati pictograma pentru a accesa interfata radio.

Puteti salva pana la 18 posturi radio FM.



7. APLICATII



Apasati pictograma pentru a deschide interfata cu toate aplicatiile instalate in sistem.

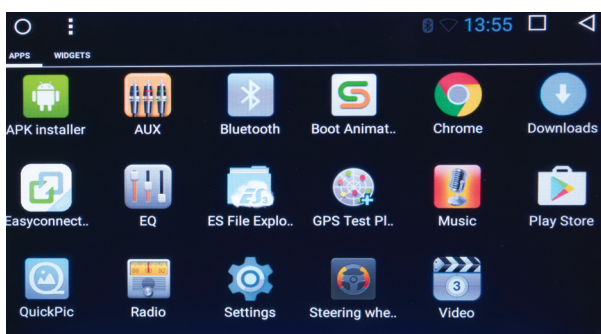

8. BLUETOOTH



Apasati pictograma pentru a accesa interfața Bluetooth.

Bluetooth este o tehnologie de comunicare wireless pe distanțe scurte (în jur de 5 m) prin care se pot schimba informații fără o conexiune fizică.

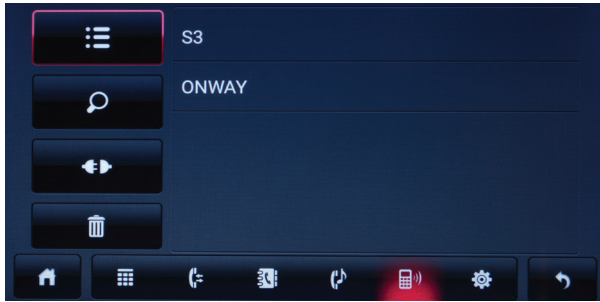

Conectați prin Bluetooth telefonul mobil și player-ul PNI A8020.

După conectarea celor două dispozitive puteți prelua și efectua apeluri, puteți importa agenda sau puteți reda muzică din telefon.

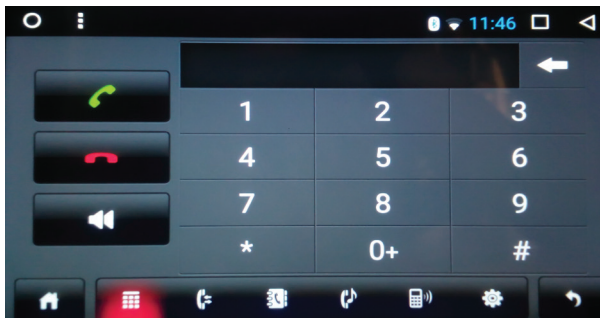

9. MUZICA



Apasati pictograma pentru a accesa interfața player-ului de muzică.

Puteti reda muzică de pe card micro SD, memorie USB sau memoria internă a player-ului.



SPECIFICATII TEHNICE:

Platforma	Allwinner T3L
OS	Android 6.0.1
CPU	Quad Core 1.0G
RAM	DDR3 1.0GB
ROM	8GB
SD	micro SD maxim 32GB (nu este inclus)
Ecran	HD 1024 x 600px
Wifi	Da
Bluetooth	A2DP

Tensiune de alimentare	12V / 10A
Putere maxima	45W x 4
iesire AV	Audio: 4.1
	Video: 2
Intrare AV	Audio: 2 canale
	Video: 2 (1 pentru camera, 1 pentru AUX in)

Suporta	SVCD/DVCD/DVD/VCD/CD/CD-R/CD-RW/ JPEG/WMA/MP3/MP4/DIVX/MP5/AVI/MPG/ TS 1080P H.264 format etc.
Frecventa FM	87.5~108 MHz

DIAGRAMA CONEXIUNI:

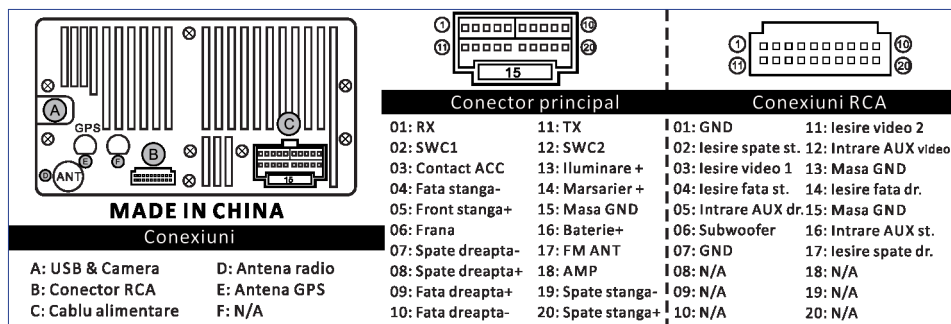

EN:

EU Simplified Declaration of Conformity

SC ONLINESHOP SRL declares that **Car multimedia player PNI A8020** complies with the Directive EMC 2014/30/EU. The full text of the EU declaration of conformity is available at the following Internet address:

<https://www.mypni.eu/products/5636/download/certifications>

BG:

Опростена декларация за съответствие на ЕС

SC ONLINESHOP SRL декларира, че мултимедийният плейър за автомобил PNI A8020 отговаря на директивата EMC 2014/30 / EU. Пълният текст на ЕС декларацията за съответствие е достъпен на следния интернет адрес:

<https://www.mypni.eu/products/5636/download/certifications>

DE:

Vereinfachte EU-Konformitätserklärung

SC ONLINESHOP SRL erklärt, dass der Multimedia-Player für Autos PNI A8020 der Richtlinie EMC 2014/30 / EU entspricht. Der vollständige Text der EU-Konformitätserklärung ist unter folgender Internetadresse abrufbar:

<https://www.mypni.eu/products/5636/download/certifications>

ES:

Declaración UE de conformidad simplificada

SC ONLINESHOP SRL declara que Multimedia player auto PNI A8020 está en conformidad con la Directiva EMC 2014/30/EU. El texto completo de la declaración de conformidad de la UE está disponible en la siguiente dirección de Internet:

<https://www.mypni.eu/products/5636/download/certifications>

FR:

Déclaration de conformité simplifiée de l'UE

SC ONLINESHOP SRL déclare que le lecteur multimédia pour voiture PNI A8020 est conforme à la directive EMC 2014/30 / EU. Le texte complet de la déclaration de conformité UE est disponible à l'adresse Internet suivante:

<https://www.mypni.eu/products/5636/download/certifications>

HU:

Egyszerűsített EU Megfelelési Közlemény

SC ONLINESHOP SRL kijelenti azt, hogy a **PNI A8020 autós multimédia lejátszó** megfelel az EMC 2014/30/EU. Az EU-megfelelőségi nyilatkozat teljes szövege a következő internetes címen érhető el:

<https://www.mypni.eu/products/5636/download/certifications>

IT:

Dichiarazione UE di conformità semplificata

SC ONLINESHOP SRL dichiara che il **Letto multimediale per auto PNI A8020** è conforme alla direttiva EMC 2014/30/UE. Il testo completo della dichiarazione di conformità europea è disponibile al seguente indirizzo Internet:

<https://www.mypni.eu/products/5636/download/certifications>

RO:

Declarația de conformitate UE simplificată:

SC ONLINESHOP SRL declară că playerul multimedia pentru mașină PNI A8020 este conform cu Directiva EMC 2014/30 / UE. Textul integral al declarației UE de conformitate este disponibil la următoarea adresă de internet:

<https://www.mypni.eu/products/5636/download/certifications>